

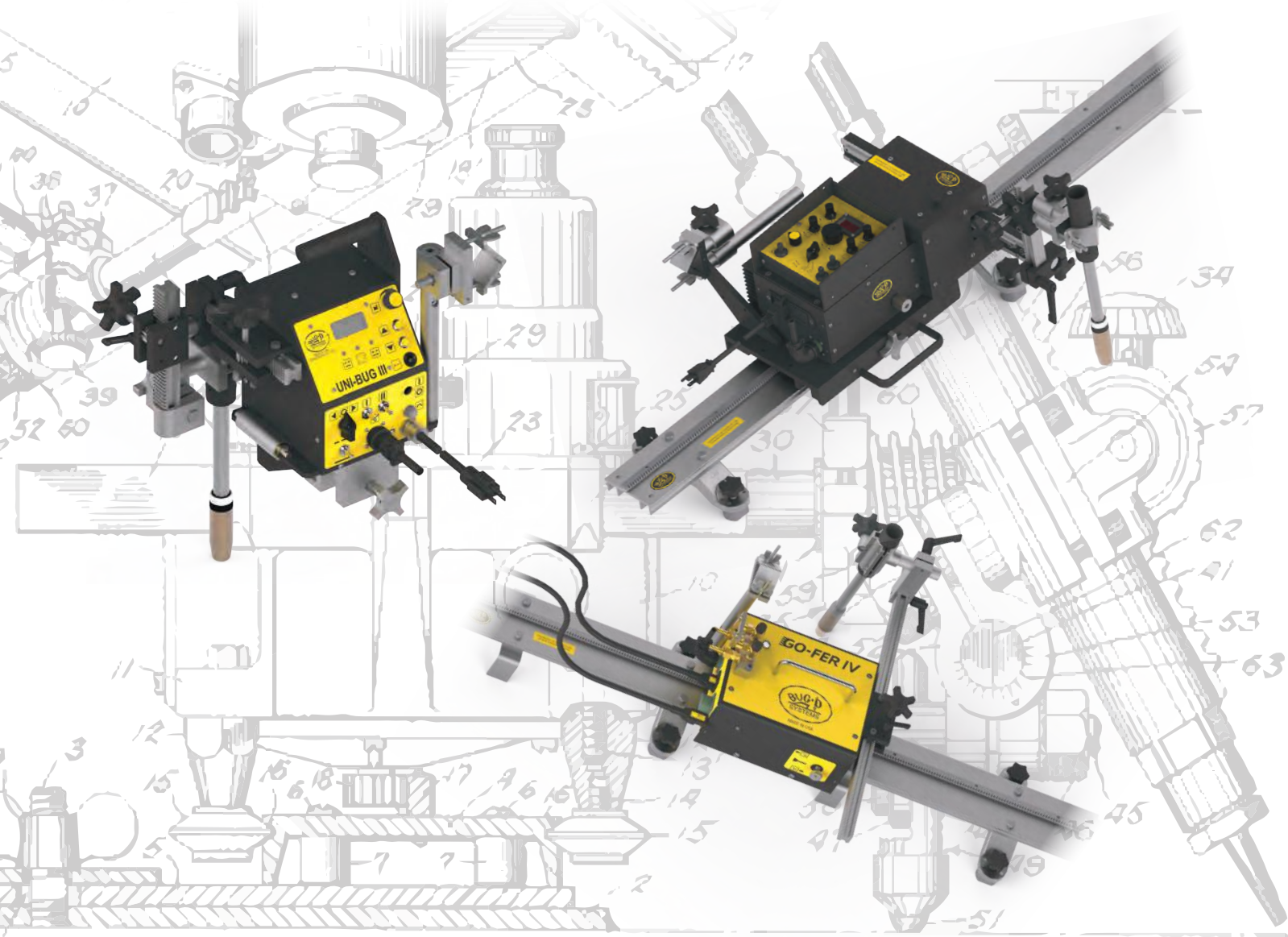

# Mechanized Cutting & Welding Systems



**Empowering People to Transform the Welding & Cutting Industry**

280 TECHNOLOGY DRIVE    CANONSBURG, PENNSYLVANIA 15317-9564    USA  
PHONE: 412-331-1776    <http://www.bugo.com>    FAX: 412-331-0383



## Bug-O Systems - Empowering People to Transform the Welding and Cutting Industry

Bug-O Systems is a Family Owned business founded in 1948. The company has grown and evolved to become an Industry Leader in the design, manufacture and application of portable mechanization products for the cutting and welding industry. Our products are designed to give our customers an excellent return on their investment. From the St. Louis Arch to Disney Cruise Ships and Pipelines all around the world, Bug-O's modular system of components can be configured to fit virtually any application.

We welcome the opportunity to discuss any application that challenges you today. We can make recommendations and would be pleased to setup a demonstration in your facility so you can see firsthand how Bug-O Systems can save you time, money and increase your quality.

## Why Choose a Mechanized Process?

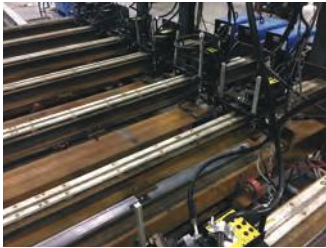

### Increase Production

The machine replaces the operator's hand to control the process. Continuous welding, no stopping and starting.

### Improve Quality

Precise speed and path control improves appearance and quality. Decreases defects and costly rework.

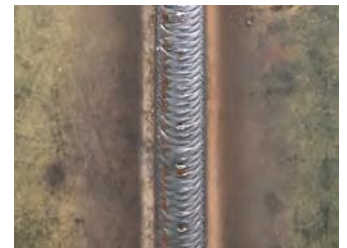

### Reduce Material Handling

Take the machine to the work. Work in all positions.

### Reduce Distortion

Regulate travel speed. Provide uniform heat input.



### Improve Worker's Environment

Reduce operator fatigue. Remove operator from welding/cutting fumes.

## TABLE OF CONTENTS

<b>Track Cutting &amp; Welding</b> .....	<b>3</b>
Modular Drive System.....	3-8
GO-FER IV®.....	9-10
DC-IV.....	11
Heavy Duty DC-IV.....	11
<b>Track Welding</b> .....	<b>12</b>
Universal Bug-O-Matic.....	12-13
Zipper Welder.....	14
<b>Trackless Welding</b> .....	<b>15</b>
UNI-BUG III.....	15-16
Stiffener Welder.....	17
Gear Driven Fillet Welders.....	18
Dual Torch Fillet Welder.....	19
Fillet Welder with Oscillation.....	20
Vertical Wall Fillet Welder.....	21
<b>Weave Welding</b> .....	<b>22</b>
Stand Alone Pendulum Weave Welder.....	22
Stand Alone Linear Weave Welder.....	23
<b>Circle Welding</b> .....	<b>24</b>
CW-5.....	24
CWE-5.....	25
CW-5AX.....	26
CWE-5AX.....	27
CW-7.....	28
CWE-7.....	29
CW-18.....	30
<b>Circle Cutting</b> .....	<b>31</b>
HOB-O®.....	31
Plasma Circle Burner.....	32
Plasma Circle Burner with Remote Control.....	33
Oxy-Fuel Circle Burner for Square or Beveled Hole Cuts.....	34
CB-3 / CB-3H.....	35
<b>Pipe Cutting &amp; End Preparation</b> .....	<b>36</b>
Programmable Pass Through Pipe Cutting Machine.....	36
Programmable Dual Function Elbow and Saddle Cutter.....	37
Programmable Pass Through Pipe Cutting Machine.....	38
Pipe Coupon Cutting Machine.....	39
Programmable Pipe Cutter.....	40
Pre-Programmed and Custom Cuts.....	41
<b>Custom Mechanization</b> .....	<b>42</b>
High Capacity Modular Drive System.....	42
All Position Overlay System.....	43
DCW-5.....	44
DCW-18.....	45
MM-5.....	46
Girth Welders.....	47
<b>Accessories</b> .....	<b>48</b>
Automatic Height Control.....	48
Racking Groups.....	49
Panographs.....	49
Torch Supports / Holders.....	50
Rails.....	50
Magnets & Their Accessories.....	51
Carriages & Vacuum Supports.....	51
Batteries.....	51



# Track Cutting & Welding

## Modular Drive System

The **Modular Drive System** is the only product in the industry that allows the user to configure one machine for multiple applications. The Master Drive Unit accepts several interchangeable control modules for programmable shape cutting or welding, straight line cutting/welding, stitch welding, programmable stitch welding, linear weaving and pendulum weaving.

### Features:

- High torque, low inertia motor
- Motor overload protection
- Closed loop position control
- High speed linear/pendulum weaver with independent control of right and left dwell times
- Dedicated fail-safe brake
- Closed loop speed control
- Contactor on/off switch
- Custom configurable
- Made in USA

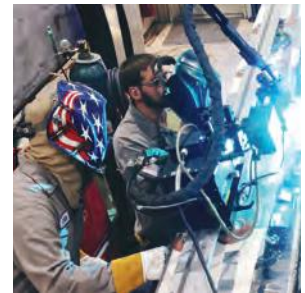

Modular Drive System Kits are all in one packages based upon application. All kits include: master drive, control module, racking, torch holder, rail and magnets. Only the welding kits include a torch with the kit.

### Straight Line Kits



**Straight Line Welding Kit**

MDS-4000 (120 VAC)  
MDS-4002 (240 VAC)  
MDS-4004 (42 VAC)



**Straight Line Plasma Cutting Kit**

MDS-4100 (120 VAC)  
MDS-4102 (240 VAC)  
MDS-4104 (42 VAC)

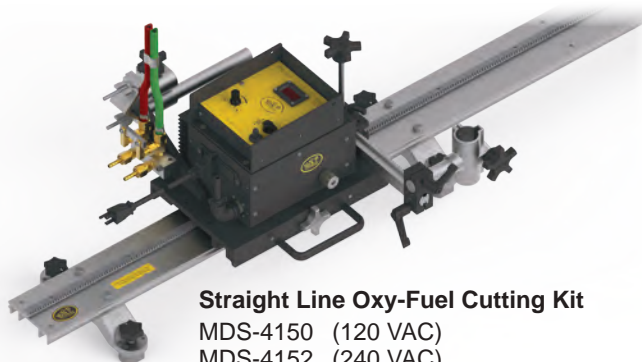

**Straight Line Oxy-Fuel Cutting Kit**

MDS-4150 (120 VAC)  
MDS-4152 (240 VAC)  
MDS-4154 (42 VAC)



## Hi-Flex Straight Line Kits



### Hi-Flex Welding Kit

FMD-4000 (120 VAC)  
FMD-4002 (240 VAC)  
FMD-4004 (42 VAC)

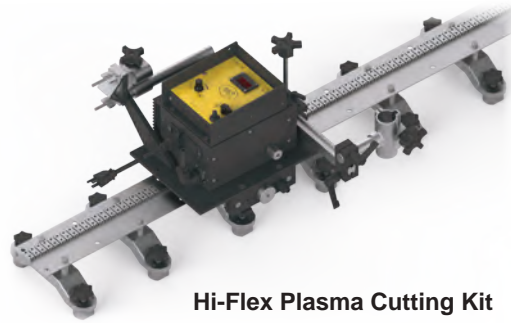

### Hi-Flex Plasma Cutting Kit

FMD-4100 (120 VAC)  
FMD-4102 (240 VAC)  
FMD-4104 (42 VAC)



### Hi-Flex Oxy-Fuel Cutting Kit

FMD-4150 (120 VAC)  
FMD-4152 (240 VAC)  
FMD-4154 (42 VAC)

## Straight Line Weaver Kits



### Straight Line Linear Weaver Kit

MDS-4200 (120 VAC)  
MDS-4202 (240 VAC)  
MDS-4204 (42 VAC)

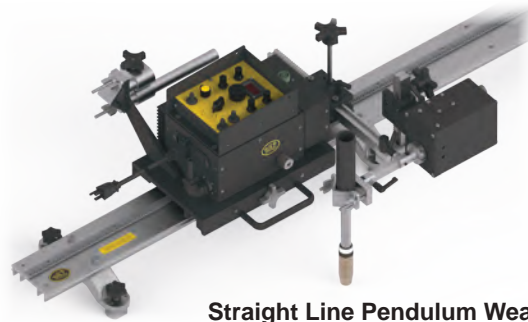

### Straight Line Pendulum Weaver Kit

MDS-4300 (120 VAC)  
MDS-4302 (240 VAC)  
MDS-4304 (42 VAC)

## Straight Line Stitch Kits



### Straight Line Programmable Stitch Kit

MDS-4400 (120 VAC)  
MDS-4402 (240 VAC)  
MDS-4404 (42 VAC)

## Hi-Flex Straight Line Weaver Kits



**Hi-Flex Linear Weaver Kit**  
FMD-4200 (120 VAC)  
FMD-4202 (240 VAC)  
FMD-4204 (42 VAC)



**Hi-Flex Pendulum Weaver Kit**  
FMD-4300 (120 VAC)  
FMD-4302 (240 VAC)  
FMD-4304 (42 VAC)

## Hi-Flex Straight Line Stitch Kits



**Hi-Flex Programmable Stitch Kit**  
FMD-4400 (120 VAC)  
FMD-4402 (240 VAC)  
FMD-4404 (42 VAC)

## Programmable Shape Kits

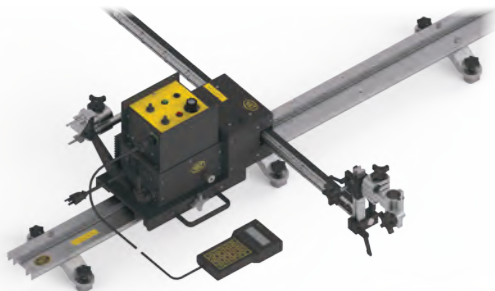

**Programmable Shape Plasma Cutting or Welding Kit**  
Contact factory for details.

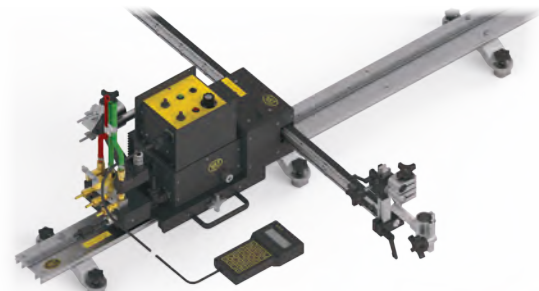

**Programmable Shape Oxy-Fuel Cutting Kit**  
MDS-4550 (120 VAC)  
MDS-4552 (240 VAC)  
MDS-4554 (42 VAC)

## Hi-Flex Programmable Shape Kits

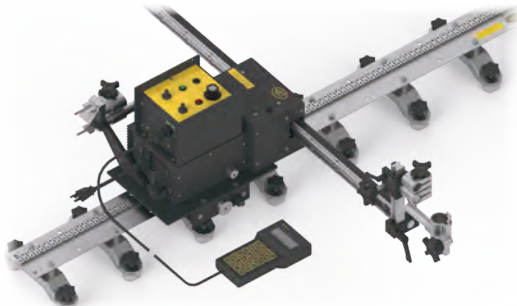

**Hi-Flex Prog. Shape Plasma Cutting or Welding Kit**  
Contact factory for details.

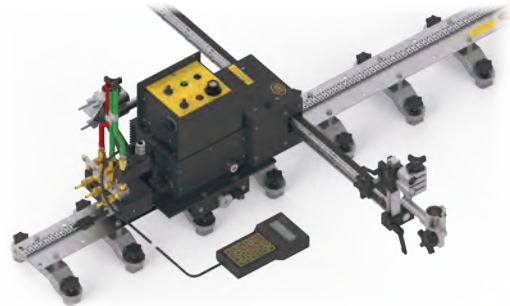

**Hi-Flex Prog. Shape Oxy-Fuel Cutting Kit**  
FMD-4550 (120 VAC)  
FMD-4552 (240 VAC)  
FMD-4554 (42 VAC)

# How to Create a Modular Drive System

Choose from the options below to fit your application.

## 1 RAILS

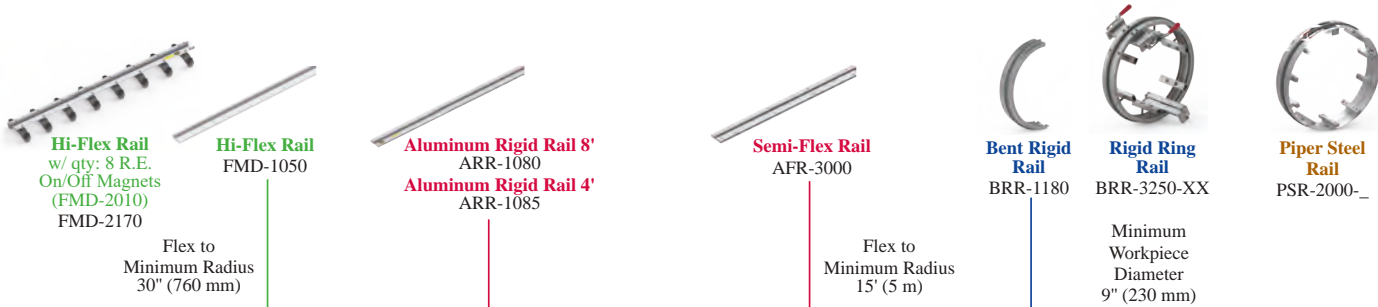

## 2 A. MAGNETIC ATTACHMENTS\*

\*Additional magnets available, see "Rails & Attachments" brochure for more info.

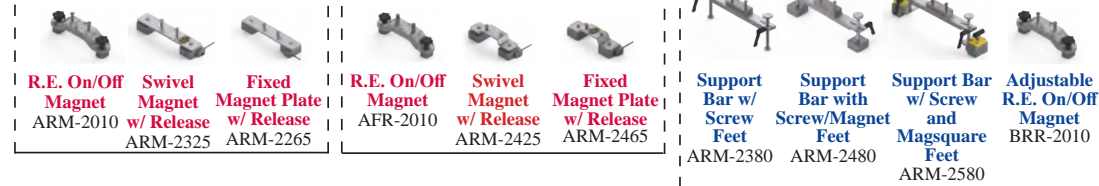

## B. NON-FERROUS ATTACHMENTS

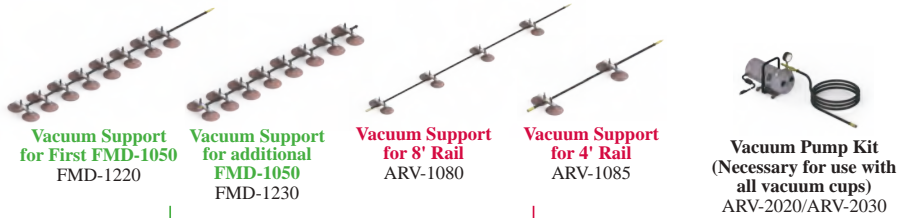

## 3 CARRIAGES

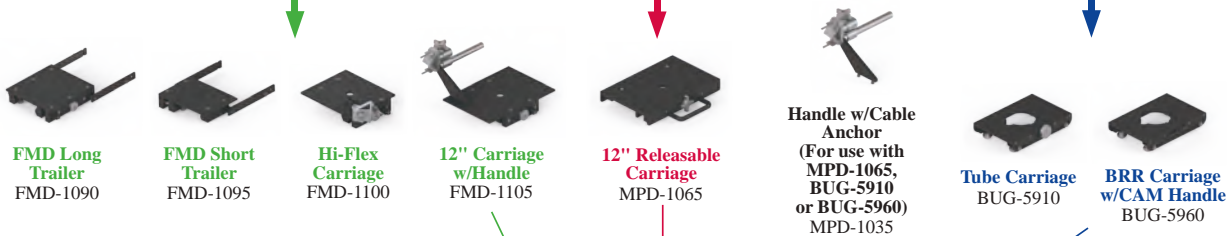

## 4 MASTER DRIVE UNIT

\*MPD-1000 120 VAC  
\*MPD-1002 240 VAC  
\*MPD-1004 42 VAC

\*CSA models are available upon request.

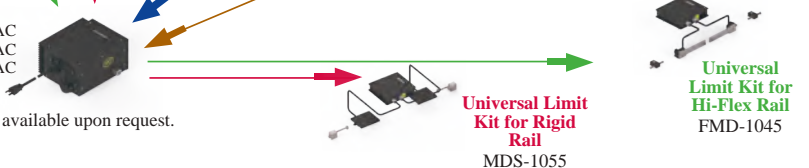



## 5 STRAIGHT LINE CUTTING & WELDING OR ARC GOUGING

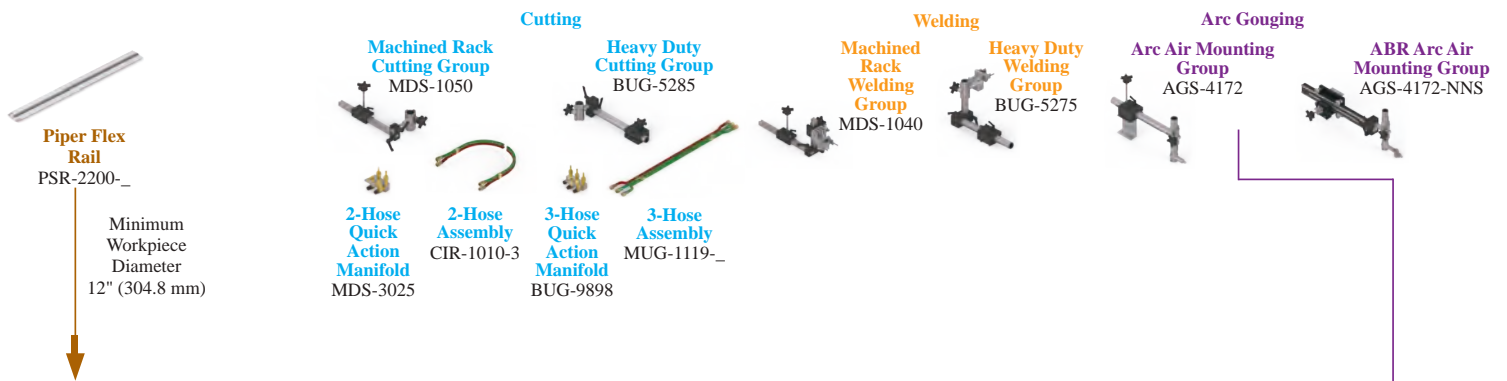

## 6 WEAVE WELDING

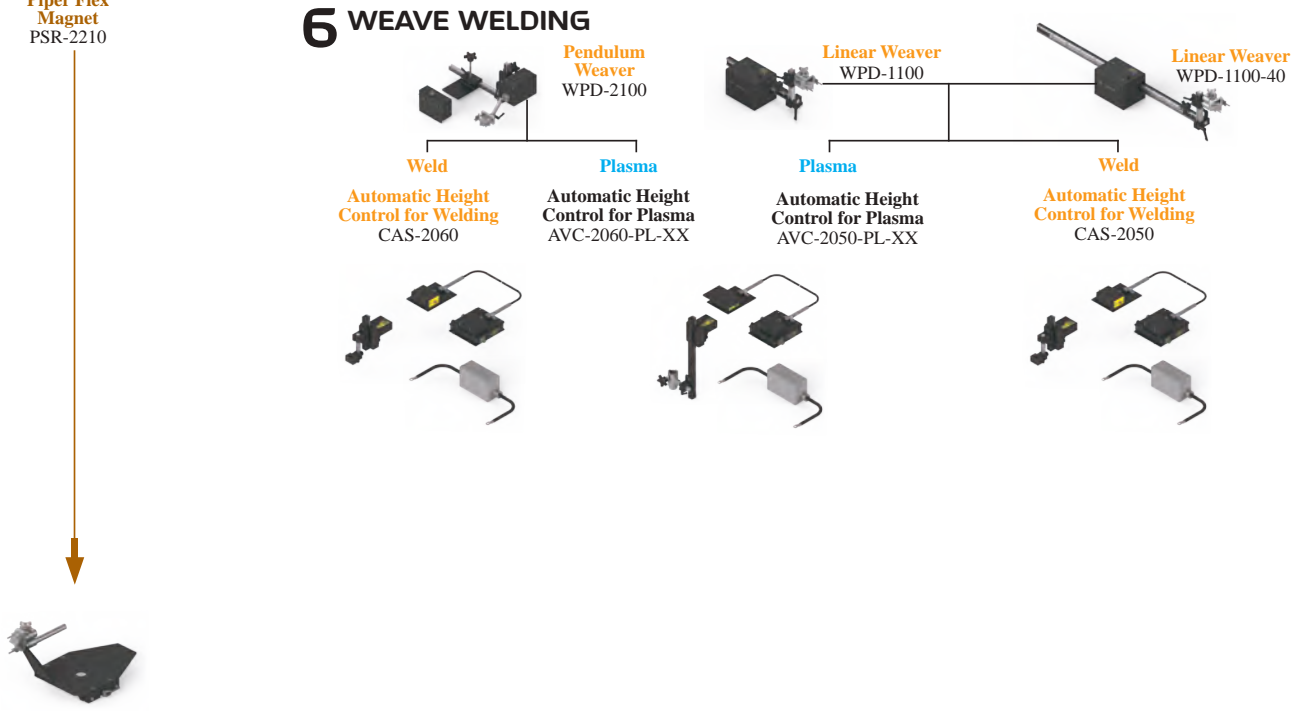

## 7 CONTROL MODULES

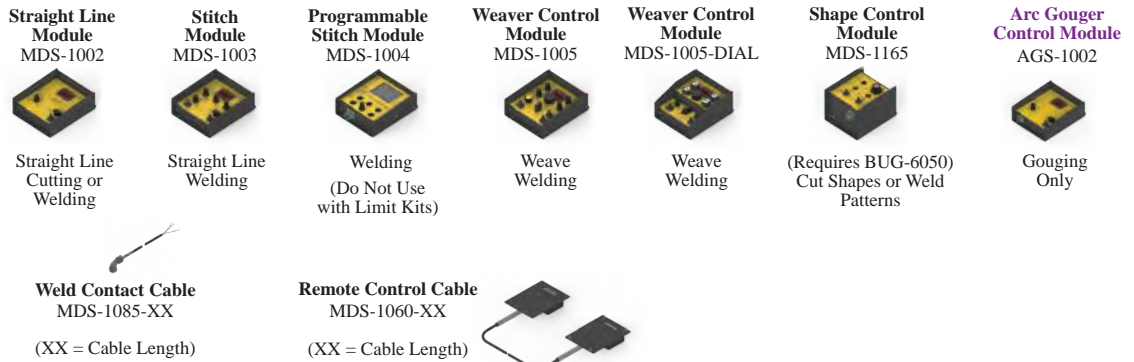

## Modular Drive System - Modules and Applications



The Modular Drive System can be used for straight line cutting or welding. The Modular Drive System is capable of traveling from 2-120 ipm, has a vertical load capacity of 60 lbs, and a horizontal load capacity of 100 lbs. The straight line module features a switch for travel functions and a digital readout of speed control along with a contactor switch. The MDS runs on any Bug-O rail when using the appropriate carriage.

The Modular Drive System with the Linear Weaver is commonly setup to weld beveled butt joints or overlay surfaces and can be used in any position. It is capable of weave widths from 1/8 to 2" and weave speeds up to 100 ipm. The weaver control module operates the linear weaver as well as the master drive unit. The optional remote cable can be used to put the control module in the operator's hands.

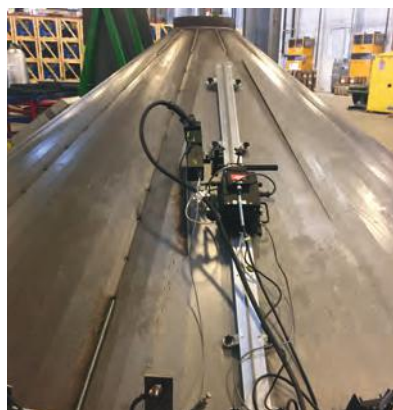

The Modular Drive System with the Pendulum Weaver is commonly used for fillet welds, horizontal and overhead welds. It is capable of weave widths from 1/8 to 2" and weave speeds up to 100 ipm. The Pendulum Weaver control module operates the pendulum weaver as well as the master drive unit. The optional remote cable can be used to put the control module in the operator's hands.

The Modular Drive System with the Programmable Stitch Module is commonly used when stitch welds are required. The Programmable Stitch Module is also popular in production areas where the same part is being welded repeatedly and consistent quality is required. Additionally, this module is capable of running two torches at the same time for even further increased productivity. The optional remote cable can be used to put the control module in the operator's hands. Programming the stitch module is easy; the graphic screen prompts you to enter weld length, skip length, crater fill, travel delays and the total number of welds to be made. This ensures high quality repeatable welds every time.

The Modular Drive Programmable Shape Machine is a portable, easy to use, dual axis machine. You can program the shape machine module to run any contour or pattern for welding and oxy-fuel or plasma cutting applications in any position. The supplied handheld pendant is used to program the required shape and operational sequence such as starts, stops, time delays, repeats and rapid travel. Up to 20 programs can be stored in the shape machine's module memory at any one time. The Bug-O shapes program provides for unlimited shape storage and easy shape editing on any pc. The Modular Drive System Programmable Shape Machine is compact and portable and can easily be carried anywhere.



# GO-FER® IV



The **GO-FER® IV** is a portable, versatile and robust tractor designed for many of your cutting and welding needs. When used for cutting, you can utilize either oxy-fuel or plasma torches. It can also carry a plasma torch for gouging. The GO-FER® IV can be used in all positions. The system includes a rack & pinion drive and the wheels are secured within the V groove in the sides of the rail. These features allow travel in any plane, even upside down.

When utilized for straight line cutting and beveling with an oxy-fuel torch, this unit includes everything required except the torch itself. The torch holder will accept any standard 1-3/8" (35mm) diameter machine torch with a 32 pitch gear rack. The quick-action gas manifold mounted to the rear of the machine is used as a strain reliever for the torch hoses and gives the operator the ability to turn the gases on and off without having to readjust the gas flow of the torch. The Cable Anchor provides strain relief for the supply hoses and power cord.

## Features:

- A drive motor to suit all applications with speeds from 2.5 to 100 ipm (63.5-2540 mm/min)
- Bright digital, pre-settable travel speed meter for actual travel speed in inches per minute
- Large industrial, sealed rocker switches (welding glove friendly)
- Power cord with plug-in lock
- Low profile case
- Dynamic braking of motor prevents drift in all positions
- Made in USA
- Two independent, built-in contactors for dual torch applications
- Quick-action gas manifold, twin-hose assembly and cable anchor
- Torch adjustment racking for oxy-fuel and plasma cutting
- Top central carrying handle
- Supported by our 3-Year Warranty
- An international version (GOF-4002) includes a 240v power cord and twist-lock plug

With an ample speed range of 2.5-100 ipm (63.5-2540 mm/min) and direct rack and pinion drive, the GO-FER® IV is perfectly designed to work in conjunction with a plasma cutting system. The GO-FER® IV includes a built-in contactor switch to turn the plasma on and off. Easy torch adjustment is provided to make straight plasma cuts and bevels. With the right tip in the plasma torch you can perform mechanized gouging without changing machines.

The Welding Kit provides everything you need for in-process torch adjustment of the vertical and horizontal plane, including the welding support and torch. The fits-all clamp will accept and accommodate any hand held or machine barrel welding gun and allow the operator to position the gun at any angle they desire. The built-in trigger contactor allows the operator to activate the wire feeder from a switch on the top of the unit.

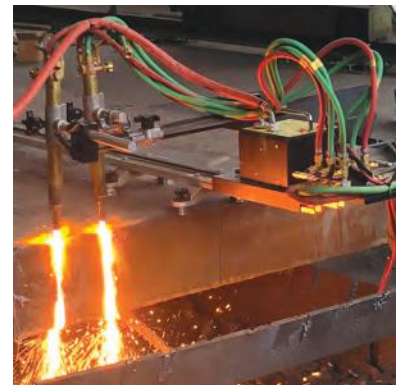





**GO-FER IV® Base Machine**  
 GOF-4001 (120 VAC)  
 GOF-4003 (240 VAC)



**GO-FER IV® Base Machine with Pendant**  
 GOF-4101 (120 VAC)  
 GOF-4103 (240 VAC)

## GO-FER® IV Kits



**GO-FER IV® Welding Kit**  
 GOF-4000-WD (120 VAC)  
 GOF-4002-WD (240 VAC)



**GO-FER IV® Kit  
 (Oxy-Fuel Setup Shown)**  
 GOF-4000 (120 VAC)  
 GOF-4002 (240 VAC)



**GO-FER IV® Kit  
 (Plasma Setup Shown)**  
 GOF-4000 (120 VAC)  
 GOF-4002 (240 VAC)



**GO-FER IV® Welding Kit  
 with Pendant**  
 GOF-4100-WD (120 VAC)  
 GOF-4102-WD (240 VAC)



**GO-FER IV® Kit with Pendant  
 (Oxy-Fuel Setup Shown)**  
 GOF-4100 (120 VAC)  
 GOF-4102 (240 VAC)



**GO-FER IV® Kit with Pendant  
 (Plasma Setup Shown)**  
 GOF-4100 (120 VAC)  
 GOF-4102 (240 VAC)

## DC-IV

The **DC-IV** is a dual speed range, positive rack & pinion drive, ready for mounting welding or cutting attachments and accessories. It consists of a DC-IV Drive unit mounted on a 12" (305 mm) Carriage. This unit runs on standard Aluminum Rigid Rail & Aluminum Flex Rail.

### Features:

- Forward-off-reverse switch
- Cam clutch engages and disengages the drive
- Circuit breaker
- Factory installed pinion provides a high torque, low speed range
- Alternate pinion bypasses the bull gear to obtain a low torque, high speed range
- Made in USA



### DC-IV

BUG-034\_ (120 VAC)  
BUG-044\_ (240 VAC)  
BUG-054\_ (42 VAC)

## Heavy Duty DC-IV



The **Heavy Duty DC-IV** is the base of the DC-IV with heavy duty racking. This makes the machine suitable for harsh environments such as steel mills. The rigid torch holder provides robust torch support, so the torch doesn't bounce or deflect during operation. The racking is available in our standard lengths: 19", 33" or 40".

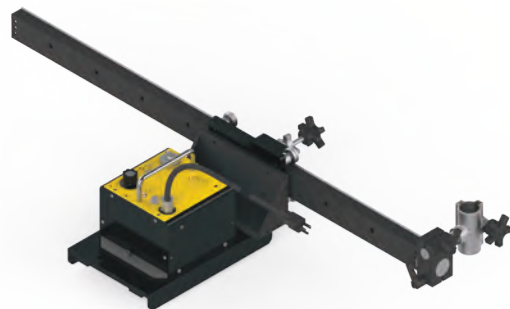

### DC-IV Heavy Duty Racking Upgrade Kit

100-0442-19 19" length racking  
100-0442-33 33" length racking  
100-0442-40 40" length racking

# Track Welding

## Universal Bug-O-Matic



The **Universal Bug-O-Matic** is a compact unit which combines a powerful drive and precision oscillator all in one housing. The unit is lightweight and can easily be handled by one operator. The machine works in all positions and can be used for vertical and overhead welds. By simply changing the carriage, the unit can work on rigid rail, semi-flex rail, hi-flex rail or complete ring rails. The opening mechanism of the carriage allows the unit to be released or installed anywhere on the rail.

While welding, adjustments can be made to the travel speed, amplitude and oscillation speed as well as dwell left and dwell right. While the machine is welding, the torch can be guided by a separate steering knob. Closed loop feedback and dynamic braking allow the Bug-O-Matic to make precise starts, stops and travel at a constant speed.

The **Universal Bug-O-Matic with Auto Height Control** has the same functions as the Universal Bug-O-Matic, but also features amperage-sensing, automatic torch height adjustment which maintains constant torch to work distance. The Height Control features a motorized slide which provides a total of 2" (51 mm) of vertical travel.

### Features:

- Compact unit with drive and oscillator in one housing
- Closed loop feedback and dynamic breaking
- Optional automatic height control available
- Independent left and right dwell controls
- Made in USA
- Lightweight and portable
- Works in all positions
- Remote control pendant
- Control orientation reversing switch



**Universal Bug-O-Matic**  
BUG-5700 (120 VAC)  
BUG-5702 (240 VAC)  
BUG-5704 (42 VAC)

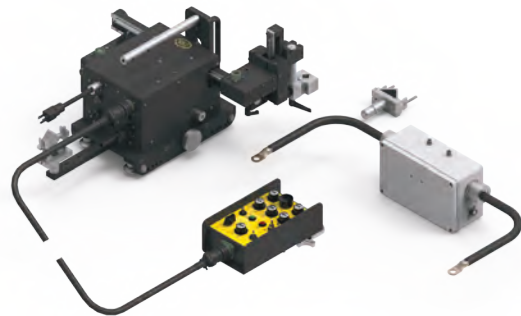

**Universal Bug-O-Matic with Automatic Height Control**  
BUG-6550 (120 VAC)  
BUG-6552 (240 VAC)  
BUG-6554 (42 VAC)



# Universal Bug-O-Matic Options

## 1 RAILS



**Hi-Flex Rail** 57.72"  
(1.47 mm) - Flex to  
minimum radius 30"  
(760 mm)  
FMD-1050



**Aluminum  
Rigid Rail 8'** (2.37 m)  
ARR-1080



**Semi-Flex Rail**  
8' (2.37m) - Flex to  
minimum  
radius 15' (5 m)  
AFR-3000



**Bent Rigid  
Rail**  
BRR-1180

**Rigid Ring Rail**  
BRR-3250-XX

**Piper Steel  
Rail**  
PSR-2000-  

**Piper Flex  
Rail**  
PSR-2200-  

Minimum  
Workpiece  
Diameter  
9" (230 mm)

Minimum  
Workpiece  
Diameter  
12" (304.8 mm)

## 2 ATTACHMENTS



**Vacuum Cup**  
FMD-1036



**R.E. On/Off  
Magnet**  
FMD-2010



**Swivel  
Magnet  
w/ Release**  
FMD-2325



**Support  
Bar w/  
Screw Feet**  
ARM-2380



**Support Bar  
w/ Screw-  
Magnet Feet**  
ARM-2480



**Support Bar  
w/ Screw and  
Magsquare Feet**  
ARM-2580



**Piper Flex  
Magnet**  
PSR-2210



**Vacuum  
Cups**  
ARV-1036



**R.E. On/Off  
Magnet**  
ARM-2010



**Swivel  
Magnet  
w/ Release**  
ARM-2325



**Fixed  
Magnet Plate  
w/ Release**  
ARM-2265



**Vacuum Cups**  
ARV-1036



**R.E. On/Off  
Magnet**  
AFR-2010



**Swivel  
Magnet  
w/ Release**  
ARM-2425



**Fixed  
Magnet Plate  
w/ Release**  
ARM-2465

For more information on vacuum cups, magnets and rails, please see the corresponding rail page in the "Rails and Attachments" brochure in order to match the correct attachments with your rails.

## 3 CARRIAGES



**Hi-Flex  
Carriage**  
FMD-1022



**12" (305 mm)  
Releasable  
Carriage**  
MPD-1065



**Tube Carriage**  
BUG-5960

## 4 UNIVERSAL BUGOMATIC

### Universal Bugomatic

BUG-5700 120 VAC  
BUG-5702 240 VAC  
BUG-5704 42 VAC



### Universal Bugomatic with Automatic Height Control

BUG-6550 120 VAC  
BUG-6552 240 VAC  
BUG-6554 42 VAC



### Universal Bugomatic for Pipe with Piper-Flex Rail

BUG-6550-QC-PSR



# Zipper Welder

The **Zipper Welder** is designed to weld vertical seams on field storage tanks. The system is composed of two standard components: box rail assembly with carriage and the Modular Drive tractor. The box rail assembly with carriage hangs over the top lip of the course section. It can be rolled into position and is held there by powerful on/off magnets. There are box rails available for 8' (2.5 m) seams and 10' (3 m) seams. The Zipper Welder utilizes the Modular Drive tractor and offers systems setup with pendulum or linear weavers. There is also an optional Automatic Torch Height Control System available for each unit.

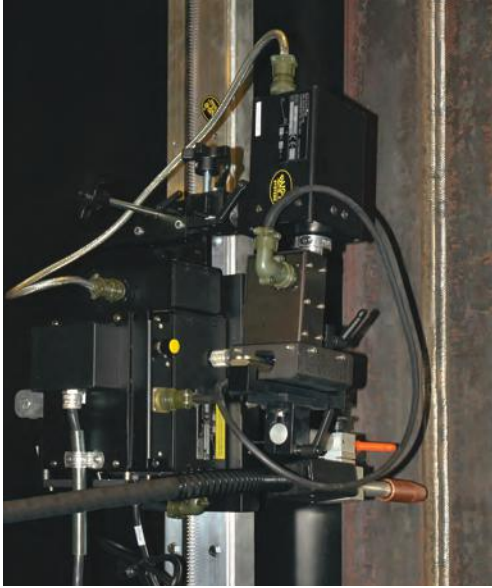

## Features:

- Pendulum or linear weaver
- Digital readout
- Forward/stop/reverse switch
- Made in USA
- Mode selector switch
- Weave speed control up to 100 in/min (254 cm/min)
- Optional automatic height control



### Zipper Welder with Linear Weaver Kit

BUG-5880 (120 VAC)  
BUG-5882 (240 VAC)

### Zipper Welder with Pendulum Weaver Kit (not shown)

BUG-5890 (120 VAC)  
BUG-5892 (240 VAC)

### Zipper Welder with Linear Weaver & Automatic Height Control Kit

BUG-5880-AHC (120 VAC)  
BUG-5882-AHC (240 VAC)

### Zipper Welder with Pendulum Weaver & Automatic Height Control Kit

BUG-5890-AHC (120 VAC)  
BUG-5892-AHC (240 VAC)

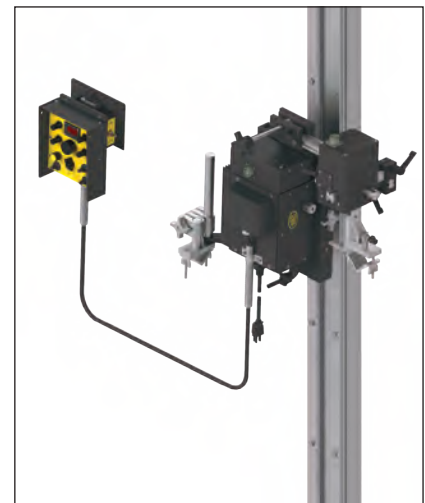

Close-up view

# Trackless Welding

## UNI-BUG III

The **UNI-BUG III** will make continuous or intermittent stitch welds. The machine will mount and run directly on the work piece. The unit is available in a variety of kits. Each kit is designed to fit on a specific steel profile such as flat bar, angle, channel, I-beams and bulb flats (holland profiles).

The UNI-BUG III features stitch welding which is programmable by distance. If you require stitch welding, simply set the selector switch to the intermittent weld setting and program the length of weld required, the length of skip and also the required delay for puddle build and crater fill. Through the use of an integrated weld contactor the UNI-BUG III will activate and deactivate your wire feeder automatically.

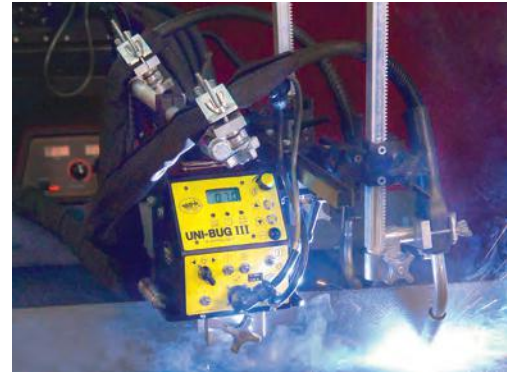

### Features:

- Programmable by distance
- Versatile - able to run on a variety of structural steel profiles
- Portable - can fit into tight work areas
- Made in USA
- Reduces material handling
- Can make continuous or intermittent stitch welds
- 50 lb. (22.7 kg) horizontal pulling capacity

The **Single Torch Kit** is equipped for the mounting of a single torch and provides components to manually adjust the torch in the vertical and horizontal plane. The UNI-BUG III provides programmable control for stitch or continuous welding and is designed to mount and run on the top edge of a flat bar or stiffener with a minimum height of 2" (50 mm) and a maximum width of 2" (50 mm). The machine will turn on a radius down to 6" (160 mm). The unit will travel at speeds from 4 to 75 inches per minute (102-1905 mm/min).

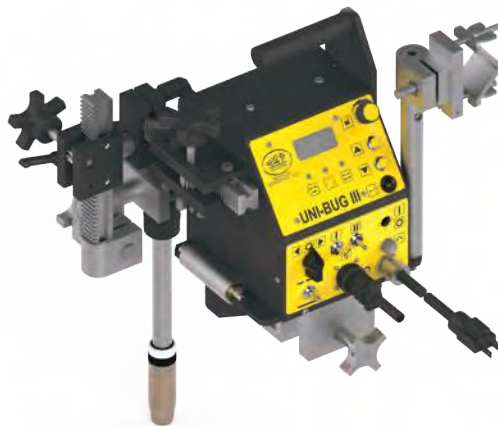

**Single Torch Kit**  
UNI-2500 (120 VAC)  
UNI-2502 (240 VAC)  
UNI-2504 (42 VAC)



The **Dual Torch Welding Kit** is the same as the Single Torch Kit, but is equipped for the mounting of two welding torches and provides components to manually adjust either torch in the vertical and horizontal plane.

The **Dual Torch Bulb Profile Welding Kit** is equipped for the mounting of two welding torches and provides components to independently adjust either torch in the vertical and horizontal plane. The unit features programmable control for stitch or continuous welding and is designed for straight line welding of bulb flats. This unit will mount and run on bulb sizes from 140 mm to 430 mm and will travel at speeds from 4 to 75 inches per minute (102-1905 mm/min).

The **Dual Torch "T" Profile Welding Kit** is equipped for the mounting of two welding torches and provides components to independently adjust either torch in the vertical and horizontal plane. The UNI-2800-4 works on "T" profiles 2"-4" (51-102 mm) range. The UNI-2800-6 works on "T" profiles 4"-6" (102-152 mm) range. The unit features programmable control for stitch or continuous welding and is designed for straight line welding of "T" profiles. This unit will mount and run on top of "T" profiles with a minimum height of 2" (50 mm) and will travel at speeds from 4 to 75 inches per minute (102-1905 mm/min).

The **Dual Torch Angle Welding Kit** is supplied with the mounts for two welding torches and provides components to independently adjust either torch in the vertical and horizontal plane. The unit features programmable control for stitch or continuous welding and is designed for straight line welding of angles. The unit will mount and run on top of angles with a minimum height of 4" (102mm) and widths up to 4" (102mm) and will travel at speeds from 4 to 75 inches per minute (102-1905mm/min).

## Typical Uni-Bug III Applications

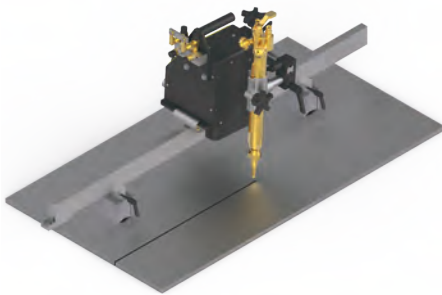

Straightline Burning and Welding

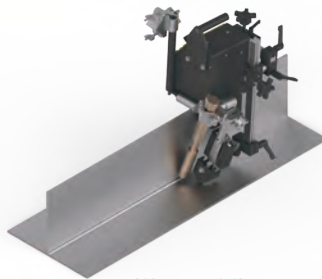

Fillet Welding



Coaming Welding  
min. 5.5" (140 mm) height

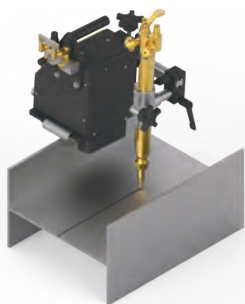

Beam Splitting

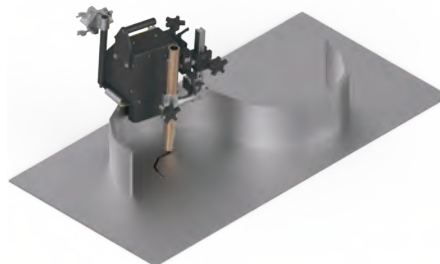

Irregular Shape Burning and Welding

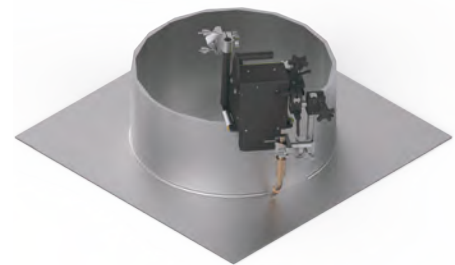

Circle Burning and Welding

# Stiffener Welder



The **Stiffener Welder** mechanizes two heavy duty wire feeders to weld "I", "T", and "Angle" stiffeners on one or both sides simultaneously. The standard machine can be set up for continuous or intermittent fillet welds on stiffeners with flange widths of 0 - 12" (0- 300 mm) and heights of 3"-16" (75 mm - 400 mm). The stiffener welder rides on four large caster wheels which make it easy to move the unit. Four guide wheels steer the unit along the stiffener and two floating, spring loaded arms with "V" rollers and spatter guards carry the welding torches and follow the joint (riding over tack welds). A heavy duty drive unit moves the stiffener welder along the work. The Stiffener Welder is available equipped with either the Lincoln Electric® Flex Feed® 84 or the Miller® S-74 wire feeders.

## Features:

- Doubles production by welding both sides of a stiffener simultaneously
- Suitable for stiffener flange widths of 0-12" (0-300 mm) and heights of 3"-16" (75-400 mm)
- Made in USA
- Reduces material handling
- Can make continuous or intermittent stitch welds



**Stiffener Welder - Lincoln Feeder**  
Contact factory for details



**Stiffener Welder - Miller Feeder**  
Contact factory for details

# Gear Driven Fillet Welders



The **K-BUG 1200** and the **K-BUG 1200-BAT** are compact, portable, straight-line tractors equipped with rugged gear drives and improved torch adjustment profiles. The Gear Drive has been incorporated to handle the strain of prolonged operation and to improve reliability. Creating continuous or intermittent “stitch” welds at a constant travel speed produces high quality, uniform welds in a fraction of the time required for manual welding. Regulated travel speed eliminates excessive weld deposition and helps reduce defects. Precise puddle control improves penetration and controls undercut.

## Features:

- State of the art digital technology insures accuracy
- Cordless 18 volt battery capable of running 2 shifts per charge (K-BUG 1200-BAT model only)
- High torque, low inertia motor for precise stops and starts
- Gear driven for greater reliability
- Drive unit motor overload protection
- Low profile, easy to access torch adjustment knobs
- Stores travel settings after power is turned off
- Programmable puddle build and crater fill times
- Weld contactor enable switch
- Carriage travel and arc start in one switch
- Guide wheels track web or flange of work piece
- Capable of traveling up to a 75° incline
- Lightweight carriage with powerful permanent magnets to grip work piece
- Closed loop speed control provides adjustable and repeatable control
- Built-in stainless limit switches stop tractor travel and welding when activated
- Digital programming of weld length, skip length and total travel distance
- Gasket sealed housing provides an IP63 rating



**K-BUG 1200**  
KBUG-1200 (120 VAC)  
KBUG-1202 (240 VAC)  
KBUG-1204 (42 VAC)



**K-BUG 1200-BAT**  
KBUG-1200-BAT (120 VAC)  
KBUG-1202-BAT (240 VAC)



# Dual Torch Fillet Welder

The **K-BUG 2000** digital, compact dual torch fillet welder is a portable straight line travel carriage that creates two continuous or intermittent “stitch” welds at a constant travel speed. The K-BUG 2000 simultaneously produces high quality, uniform welds in a fraction of the time compared to manual welding. Regulated travel speed eliminates excessive weld deposition and helps reduce defects. The machine’s guide wheels track the workpiece to provide precise, continuous weld placement.

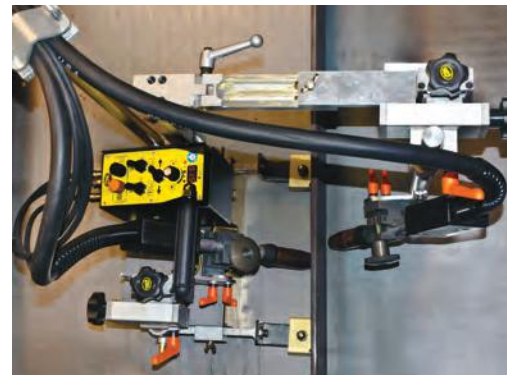

## Features:

- State of the art digital technology insures accuracy
- High torque, low inertia motor for precise stops and starts
- Drive motor overload protection
- Lightweight carriage with powerful permanent magnets to grip work piece
- Guide wheels track web or flange of work piece
- Closed loop speed control provides adjustable and repeatable control
- Stores travel settings after power is turned off
- Crater fill at the beginning and end of welding
- Two (2) weld contactor enable switches to independently activate each welding torch
- Carriage travel and arc start in one switch
- Built-in limit switches stop tractor travel and welding when activated
- Will climb up a 75° incline
- Digital programming of weld length, skip length and total travel distance



**K-BUG 2000**  
KBUG-2000 (120 VAC)  
KBUG-2002 (240 VAC)  
KBUG-2004 (42 VAC)

# Fillet Welders with Oscillation



The **K-BUG 3000** and the **K-BUG 3000-BAT** are digital, compact, heavy duty fillet welders with oscillation designed for welding fillet joints. A lightweight, portable carriage utilizes powerful magnets and guide wheel clamps to track directly on the work piece. Both units feature programmable control of weave parameters that include tractor speed, weave speed and weave width. Both K-BUGs also have independent settings for left / right dwell as well as the capability to perform in horizontal, vertical and flat positions.

Maximum vertical lifting capacity is 50 lbs (22.7 kg). Safety cables are recommended to protect the operator and equipment.

Control of all tractor and welding functions can be set or adjusted on the tractor's panel or remotely via a remote control. Remote range is up to 32 ft (10 m) away.

## Features:

- Digital compact all position fillet welder
- Cordless 18 volt battery capable of running two shifts (K-BUG 3000-BAT model only)
- State of the art digital technology insures accuracy
- Industry's smallest and lightest all position oscillating fillet welder
- Digital LED display of all parameters
- Permanent magnet for powerful traction
- Closed loop speed and position control
- Spatter guard on work-side wheels
- Drive wheels are rated to 400°F (204°C)
- Available in two voltages: 120 VAC and 240 VAC
- Limit switches provide automatic travel / weld stop
- Programmable weld control features for better puddle control and crater fill



**K-BUG 3000**  
KBUG-3000 (120 VAC)  
KBUG-3002 (240 VAC)



**K-BUG 3000-BAT**  
KBUG-3000-BAT (120 VAC)  
KBUG-3002-BAT (240 VAC)

# Vertical Wall Fillet Welder

The **K-BUG 4000** is capable of welding continuous or stitch horizontal fillet welds while traveling on a vertical wall. Constant travel speed produces high quality uniform welds. Digital programming of travel pattern and weld control eliminates excessive weld deposition and helps reduce defects. The machine's guide wheels track the workpiece to provide precise and continuous weld placement.



## Features:

- State of the art digital technology insures accuracy
- High torque, low inertia motor for precise stops and starts
- Drive unit motor overload protection
- Lightweight carriage with powerful permanent magnets to grip work piece
- Carriage Travel and arc start in one switch
- Guide wheels track web or flange of work piece
- Closed loop speed control provides adjustable and repeatable control
- Programmable control of puddle build at weld start
- Programmable control of crater fill at weld end
- Stores travel settings after power is turned off
- Weld contactor enable switch
- Built-in limit switches stop tractor travel and welding when activated
- Will climb vertical with 25 lb. (11.5 kg) capacity
- Digital programming of weld length, skip length and total travel distance



**K-BUG 4000**  
KBUG-4000 (120 VAC)  
KBUG-4002 (240 VAC)  
KBUG-4004 (42 VAC)





# Weave Welding

## Stand Alone Pendulum Weave Welder

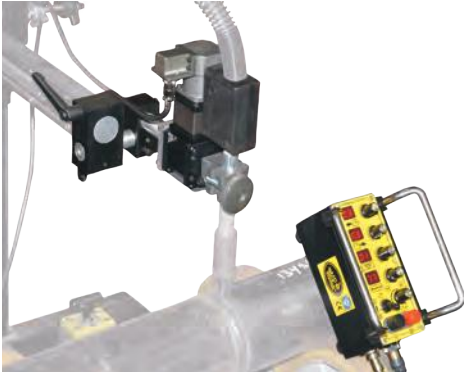

The **K-BUG 5050** is a compact unit designed for use with a torch support and positioner fixture or retrofit to a carriage. This is ideal for fillet or butt joints with flat or curved profiles. Motion parameters, including weave speed, weave width, and dwell times are digitally controlled by the remote pendant control. The pendant also offers center steering and interfaces with the welding power source to control the weld contact.

### Features:

- Compact, lightweight design for ease of use
- Independent control of dwell times from 0 - 10 seconds
- Control box equipped with magnet
- Torch “quick connect”
- Weave speed and width controls
- Modular design for a multitude of applications
- Motor with high ratio gearbox for pendulum motion prevents torch movement when power is off
- High speed motor for pendulum weaving
- Programmable puddle control and crater fill times
- Independent control of pendulum weaving right and left dwell times
- Closed loop speed control to prevent drift from center weld position
- Storage of motion parameters after power is turned off
- Weld contactor on/off switch

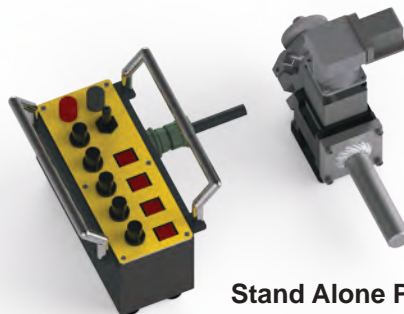

**Stand Alone Pendulum Weave Welder**  
KBUG-5050 (120 VAC)  
KBUG-5052 (240 VAC)

# Stand Alone Linear Weave Welder

The **K-BUG 6050** is a compact unit designed for use with a torch support and positioner fixture or retrofit to a carriage. This is ideal for fillet or butt joints with flat or curved profiles. Motion parameters, including weave speed, weave width, and dwell times are digitally controlled by the remote pendant control. The pendant also offers center steering and interfaces with the welding power source to control the weld contact.



## Features:

- Compact, lightweight design for ease of use
- Independent control of dwell times from 0 - 10 seconds
- Control box equipped with magnet
- Quick “torch connect”
- Weave speed and width controls
- Modular design for a multitude of applications
- Weaver motor design prevents torch movement when power is off
- Closed loop speed and position control
- High speed motor for linear weaving
- Programmable puddle build and crater fill times
- Independent control of linear weaving right and left dwell times
- Closed loop speed control to prevent drift from center of stroke
- Storage of motion parameters after power is turned off
- Weld contactor on/off switch

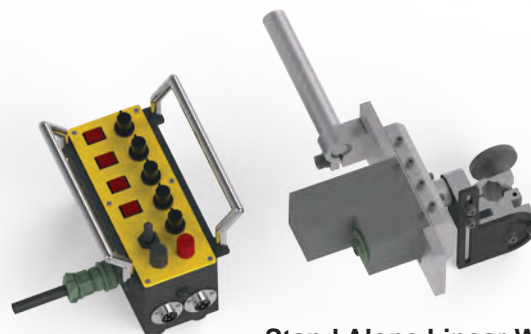

**Stand Alone Linear Weave Welder**  
KBUG-6050 (120 VAC)  
KBUG-6052 (240 VAC)

# Circle Welding

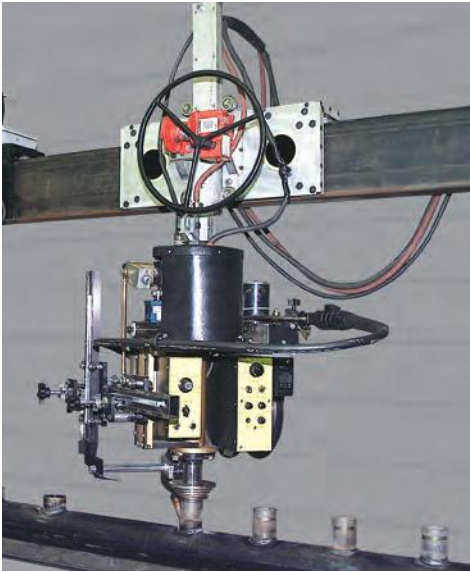

## CW-5

The **CW-5 Circle Welder** is designed for single or multi-pass welding of couplings or nozzles on pipe and vessels utilizing GMAW or FCAW process, with gas shield. The machine is equipped with its own wire feeder, rotation drive motor, rise and fall cam assembly and welding gun. Horizontal and vertical racking is used to position the torch. The CW-5 also includes a 30 lb (14 kg) spool holder. Regardless of the direction of rotation, the cable and wires do not get wrapped up or tangled. The CW-5 is supplied with the following cables: 50" (15.2 m) of gas hose, 50" (15.2 m) hot lead, 50" (15.2 m) control cable and all cables from the remote box to the circle welder.

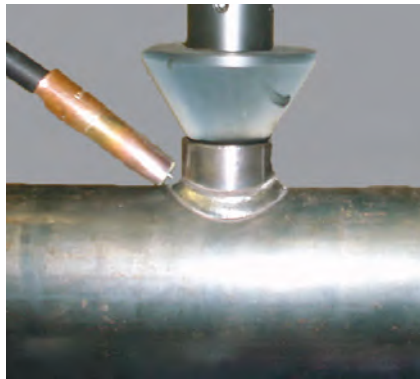

### Features:

- GMAW, FCAW process capabilities
- 1-12" (25-300 mm) welding diameter
- .035-1/16" (.8-1.6 mm) welding wire size
- Rotation speed .5-6.0 rpm
- Rise and fall cam 0-5" (0-125 mm)
- 300 amps 100% duty cycle
- Burn back control, horizontal and vertical adjustment gun & cable
- Made in USA



**CW-5 Circle Welder**  
CWO-1500



## CWE-5

The **CWE-5 with Remote Control** has a digital readout for rotation speed. It also has controls for: wire feed speed, cold inch/purge, pre-flow and post-flow, burn back and wire feeder forward and reverse. Overlap is also adjustable. This control has both manual and automatic settings. In the manual setting, you can check all your controls and travel speed to make sure the machine is functioning properly. In the automatic setting, with one push of a button, the unit will start the weld process, weld completely around the workpiece, overlap the end of the weld, turn the weld off and return to the start position. It is ready for the next weld. The CWE-5 is supplied with the following cables: 50" (15.2 m) of gas hose, 50" (15.2 m) hot lead, 50" (15.2 m) control cable and all cables from the remote box to the circle welder.

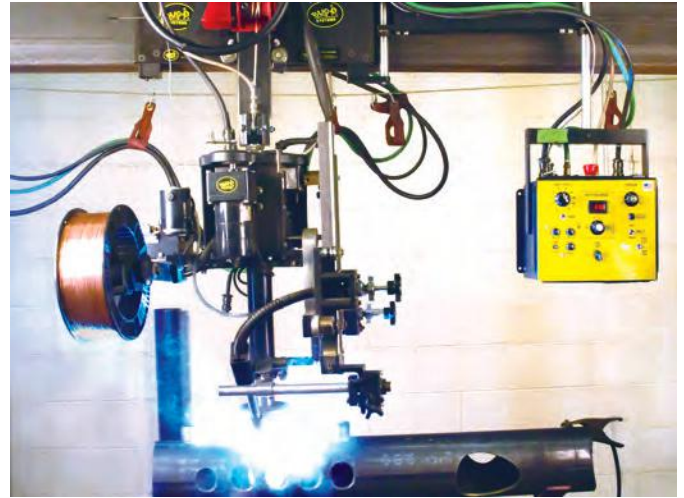

### Features:

- GMAW, FCAW process capabilities
- 1-12" (25-300 mm) welding diameter
- .035-1/16" (.8-1.6 mm) welding wire size
- Rotation speed .5-6.0 rpm
- Rise and fall cam 0-5" (0-125 mm)
- 300 amps 100% duty cycle
- Burn back control, horizontal and vertical adjustment gun & cable
- Made in USA



**CWE-5 Circle Welder**  
CWE-1500

# CW-5AX

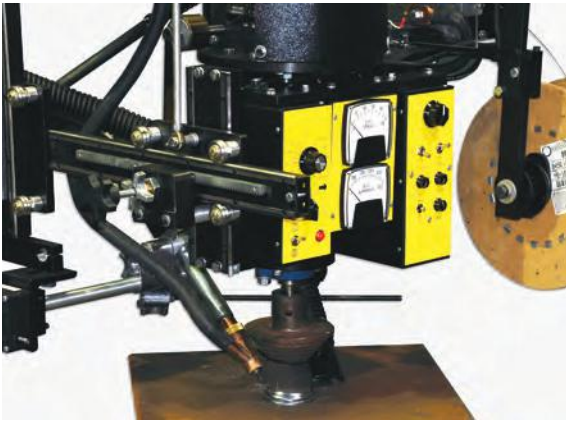

The CW-5AX Circle Welder is designed for single pass or multi pass welding of couplings and nozzles on pipe and vessels. The unit is available for SAW, GMAW or FCAW process. The CW-5AX offers all of the same features as the CW-5 as well as a meter kit, torch angle adjuster and flux hopper.

## Features:

- GMAW, FCAW and SAW process capabilities
- 1-12" (25-300 mm) welding diameter
- .035-3/32" (.8-2.4 mm) welding wire size
- Rotation speed .5-6.0 rpm
- Made in USA
- Meter kit, torch angle adjuster, flux hopper, nozzle and cone
- Rise and fall cam 0-5" (0-125mm)
- 300 amps 100% duty cycle
- Burn back control, horizontal and vertical adjustment gun & cable



**CWE-5AX**  
CWO-1560

# CWE-5AX

The **CWE-5AX Circle Welder** is designed for single pass or multi pass welding of couplings and nozzles on pipe and vessels. The unit is available for SAW, GMAW or FCAW process. The CWE-5AX offers all the same features as the CW-5 as well as a meter kit, torch angle adjuster and flux hopper.



## Features:

- GMAW, FCAW and SAW process capabilities
- 1-12" (25-300mm) welding diameter
- .035-3/32" (.8-2.4 mm) welding wire size
- Rotation speed .5-6.0 rpm
- Made in USA
- Rise and fall cam 0-5" (0-125mm)
- 500 amps 100% duty cycle
- Burn back control, horizontal and vertical adjustment gun & cable,
- Meter kit, torch angle adjuster, flux hopper, nozzle and cone



**CWE-5AX Circle Welder**  
CWE-1560



## CW-7



The **CW-7 Circle Welder** is equipped for GMAW, FCAW or SAW welding on vessels and domed heads. The CW-7 has a working range of 6"-24" (152-610 mm) O.D. nozzles with no cable wrap up for multi-pass welding. This unit is capable of using welding wire sizes from .035"-3/32" (.8-2.4 mm). The machine will carry 60 lb. (27 kg) spools of wire. The unit is complete with wire feeder, gun and cable assembly, flux hopper, wire reel and meter kit and mounts on a 3-jaw chuck.

### Features:

- GMAW, FCAW, and SAW process capabilities
- 6-24" (150-600 mm) welding diameter
- .035-3/32" (.8-2.4 mm) welding wire size
- Rotation speed .2-2.2 rpm
- Rise and fall cam 0-7" (0-175 mm)
- 500 amps 100% duty cycle
- Burn back control, horizontal and vertical adjustment gun & cable
- Made in USA



**CW-7 Circle Welder**  
CWO-1700

## CWE-7

The **CWE-7 Circle Welder** is equipped for GMAW, FCAW or SAW welding on vessels and domed heads. The CWE-7 has a working range of 6"-24" (152-610 mm) O.D. nozzles with no cable wrap up for multi-pass welding. This unit is capable of using welding wire sizes from .035"-3/32" (.8-2.4 mm). The machine will carry 60 lb. (27 kg) spools of wire. The unit is complete with wire feeder, gun and cable assembly, flux hopper, wire reel and meter kit and mounts on a 3-jaw chuck. The CWE-7 has a digital readout for rotation speed. It also has controls for: wire feed speed, cold inch/purge, pre-flow and post-flow, burn back and wire feeder forward and reverse. Overlap is also adjustable. This control has both manual and automatic settings.



### Features:

- MIG/MAG, FCAW, SAW process capabilities
- 6-24" (150-600 mm) welding diameter
- .035-3/32" (.8-2.4 mm) welding wire size
- Rotation speed .2-2.2 rpm
- Rise and fall cam 0-7" (0-175mm)
- 500 amps 100% duty cycle
- Burn back control, horizontal and vertical adjustment gun & cable
- Made in USA



**CWE-7 Circle Welder**  
CWE-1700

## CW-18



The **CW-18 Circle Welder** is designed for welding of nozzles into vessels or domed heads utilizing SAW process. The CW-18 mounts on a 3-Jaw Chuck. It is capable of welding diameters of 10" to 50" (152-1270 mm) O.D. and using welding wire diameters 3/32- 5/32" (2.4-4.0 mm). The wire feed control box provides: wire speed (amperage) control, voltage control, wire burn back, weld contact, cold wire switch, weld start parameter adjustment and weld crater parameter adjustment.

### Features:

- SAW process capability
- 10-50" (254-1270 mm) welding diameter
- Solid wire size 3/32-5/32" (2.4-4.0 mm)
- Rotation speed .2-2.2 rpm
- Rise and fall cam 0-7" (0-175 mm)
- 1200 amps 100% duty cycle
- Burn back control, horizontal and vertical adjustment gun & cable
- Made in USA



**CW-18 Circle Welder**  
CWO-1800



# Circle Cutting

## HOB-O®

The DC HOB-O® lightweight hole borer is easily carried to the work, and is quickly centered on the workpiece. All that you need is a single center punch mark. Set the hole radius on the built-in scale, light the torch, start your cut and hit the switch to make smooth accurate holes in any position; virtually eliminating the need for grinding and touchup. This flame-cutting machine will cut holes from 1" to 8" (25 mm to 200 mm) inside diameter and from 14 1/2" to 48" (368 mm to 1220 mm) outside diameter. When mounted with magnets, each magnet foot is covered with a shield to protect it from direct flame and heat.



### Features:

- Lightweight and portable, can be taken to the work piece
- Easy setup
- Cuts holes from 1-8" (25-200 mm) inside diameter
- Can cut and bevel holes with precision
- Cuts holes from 14 1/2" - 48" (368-1220 mm) outside diameter
- Made in USA



**HOB-O®**  
HOB-2303 (120 VAC)  
HOB-2323 (240 VAC)  
HOB-2313 (42 VAC)

**HOB-O® w/Magsquare Feet**  
HOB-2303-MSQ (120 VAC)  
HOB-2323-MSQ (240 VAC)

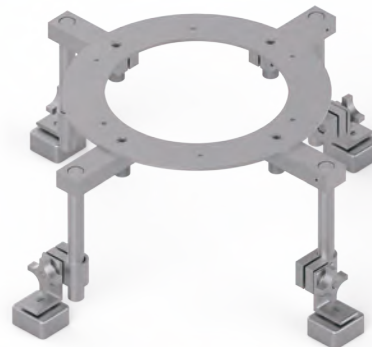

**HOB-O® Blind Area Kit**  
HOB-2080

**HOB-O® w/Blind Area Kit Combo**  
HOB-2204 (120 VAC)  
HOB-2224 (240 VAC)  
HOB-2214 (42 VAC)

### Kits

**HOB-O® w/Blind Area Kit Combo w/Magsquare Feet**  
HOB-2204-MSQ (120 VAC)

# Plasma Circle Burner

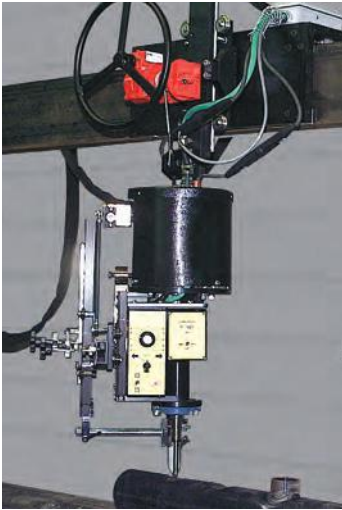

The **CB-1P** is designed for cutting beveled holes in lightwall pipe or vessels. This machine is supplied with an air plasma power source (specified by customer), torch and 50' (15 m) leads. It will cut beveled holes in light wall pipe or vessels with wall thickness up to 5/16" (7 mm). An automatic rise and fall cam controls the torch position for saddle cut holes up to 2/3 of the work diameter. The cables and air hoses supplying the unit pass through slip rings and O-rings enabling the machine to operate continuously in either direction without cable or hose wrap up. The CB-1P must be mounted on a carriage or fixture.

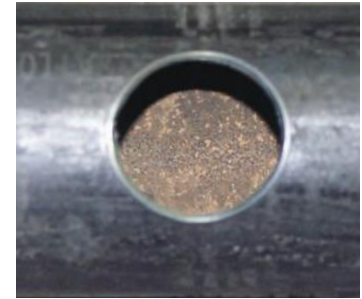
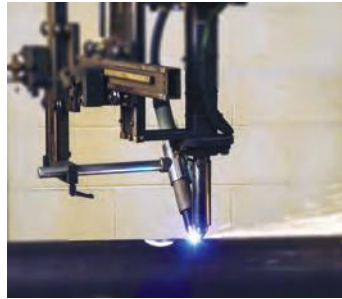

## Features:

- Plasma process
- Burning diameter of .5-12" (13-305 mm) beveled holes
- Must be mounted on a carriage or manipulator
- Rise and fall cam 5" (127 mm)
- Application type - thin wall, small diameter pipe
- Made in USA



**CB-1P Circle Burner**  
CBO-1020

# Plasma Circle Burner with Remote Control

The **CB-1PR** is designed for cutting beveled holes in lightwall pipe or vessels with wall thickness up to 5/16" (7 mm). An automatic rise and fall cam controls the torch position for saddle cut holes up to 2/3 of the work diameter. The cables and air hoses supplying the unit pass through slip rings and O-rings enabling the machine to operate continuously in either direction without cable or hose wrap up. The CB-1PR is supplied with a Hypertherm® Powermax® 65 or 85 (specified by customer) plasma power supply, 180 degree plasma machine torch and 50' (15 m) control cable / torch lead. The CB-1PR Plasma Circle Burner requires 120/50-60/1 to operate and must be mounted on a carriage or fixture. The remote pendant has the following controls: speed display, speed control, travel direction, overlap timer, cycle start, manual/auto switch, on/off switch, pilot light and quick stop.

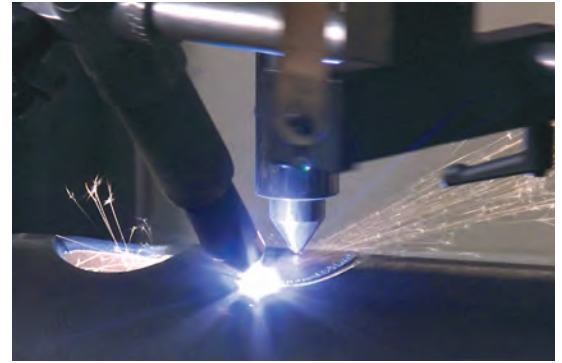

## Features:

- Remote control
- Plasma process
- Burning diameter of .5-12" (13-305 mm) beveled holes
- Made in USA
- Must be mounted on a carriage or manipulator
- Rise and fall cam 5" (127 mm)
- Application type - thin wall, small diameter pipe



**CB-1PR Circle Burner with Remote**  
CBP-2020



# Oxy-fuel Circle Burner for Square or Beveled Hole Cuts



The CB-2 is mounted on a special frame with a releasable permanent magnet base specially designed for use on vessels and large diameter pipe. The CB-2 includes variable speed rotation, 2-hose oxy-fuel machine torch, adjustable tip adapter, vertical and horizontal torch adjustment and rise and fall cam.

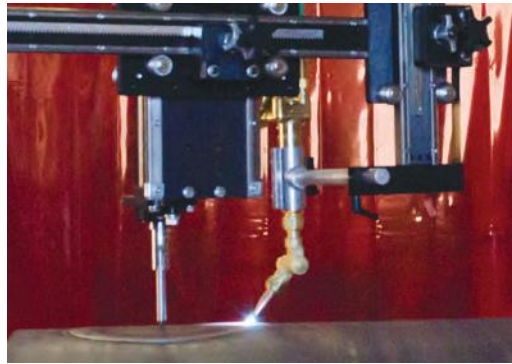

## Features:

- Oxy-fuel process
- 1.5"-42" (38-1067 mm) beveled holes
- 4"-48" (102-1219 mm) square cut
- Made in USA
- Mounted by a manually operated magnet
- Rise and fall cam 0-7" (0-178 mm)
- Application type - vessels, large diameter pipe

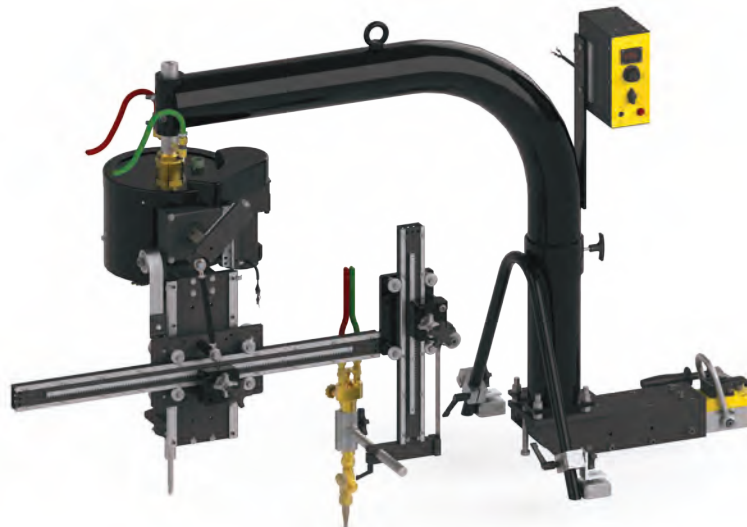

**CB-2 Circle Burner**  
CBO-2000

## CB-3 / CB-3H

The **CB-3 Circle Burner** uses the oxy-fuel cutting process for single pass, square or beveled hole cuts. It is designed for use on vessels, large diameter pipe, domed heads and flat plate. The CB-3 includes a 2-hose oxy-fuel machine torch, adjustable tip adapter, variable speed rotation, vertical and horizontal torch adjustment and rise and fall cam. The CB-3 must be mounted on a column and boom, manipulator or fixture.

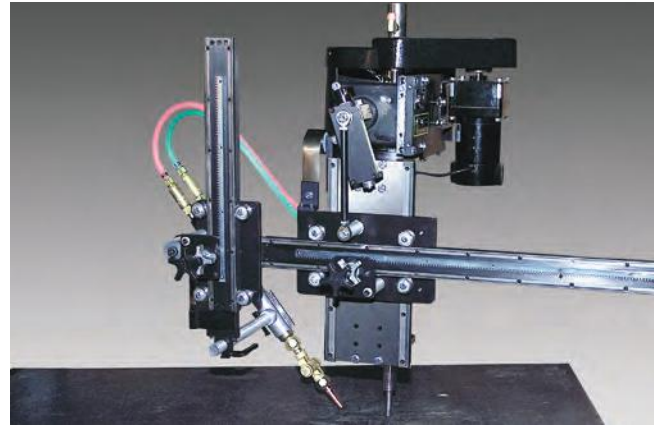

The **CB-3H Circle Burner** has the same features as the CB-3 and includes a hillside kit. This hillside kit is for *single* rise and fall motion per revolution of the machine to provide the motion required to follow the contour of an *offset* pipe-to-pipe weld.

### Features:

- Oxy-fuel process
- 1.5"-42" (38-1067 mm) beveled holes
- 4"-48" (102-1219 mm) square cut
- Adjustable vertical and horizontal torch positioning system
- Must be mounted to a carriage or manipulator
- Rise and fall cam 0-7" (0-178 mm)
- Application type - domed heads, vessels, large
- Made in USA

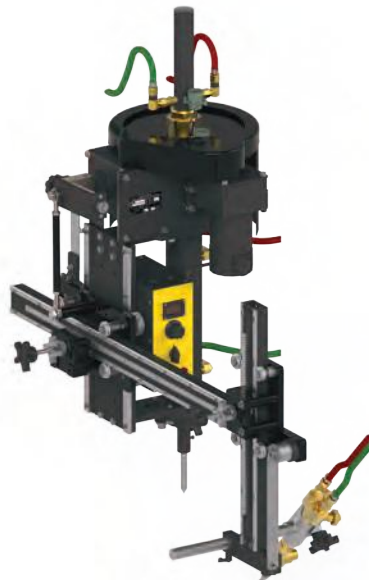

**CB-3 Circle Burner**  
CBO-3000 / CBO-3010

# Pipe Cutting & End Preparation



## Programmable Pass Through Pipe Cutting Machine

The SE-2PTD is used to cut saddles, offset saddles, laterals, miter cuts and holes on pipe. A second (selectable) program is used for cutting customized shapes in pipe. Also available is Windows based software for programming. This machine can be configured for oxy-fuel, plasma or both. The SE-2PTD eliminates the need to make templates or to layout complex cuts.

### Features:

- Dual programming capabilities
- Pipe weight capacity of 375 lbs. (170 kg)
- Pass through cutting diameter from 1-4" (25 mm to 100 mm) O.D.
- Speed range of 3.75 rpm
- Pipe cutting diameter when externally chucked from 4-14" (100-355 mm) diameter
- Made in USA

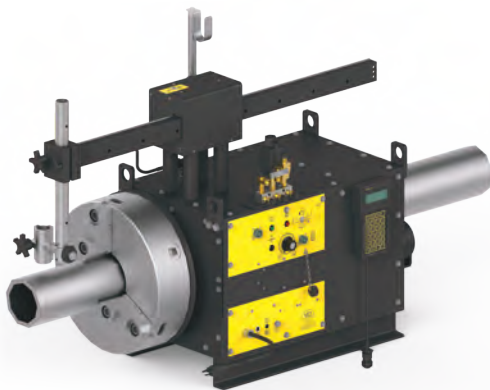

**SE-2PTD**  
SEO-4250-OX 120V Oxy-Fuel  
SEO-4252-OX 240V Oxy-Fuel

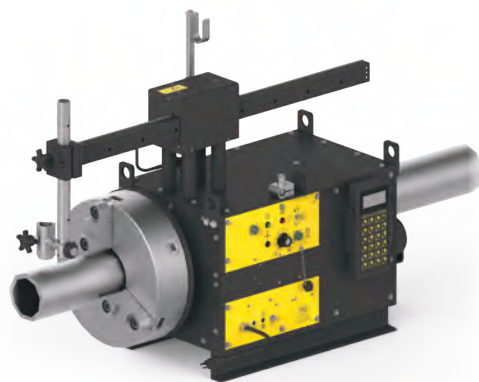

**SE-2PTD**  
SEO-4250-PL 120V Plasma  
SEO-4252-PL 240V Plasma



# Programmable Dual Function Elbow and Saddle Cutter

The SE-4PD provides dual programming capabilities enabling the user to make saddle cuts, offset cuts, laterals, miters, holes and shapes in pipes thus eliminating the need to make templates and layouts. Also available is Windows based software for programming. The SE-4PD can accommodate pipe sizes ranging from 1"-12" (25-305 mm) in diameter and is available for plasma and oxy-fuel cutting.

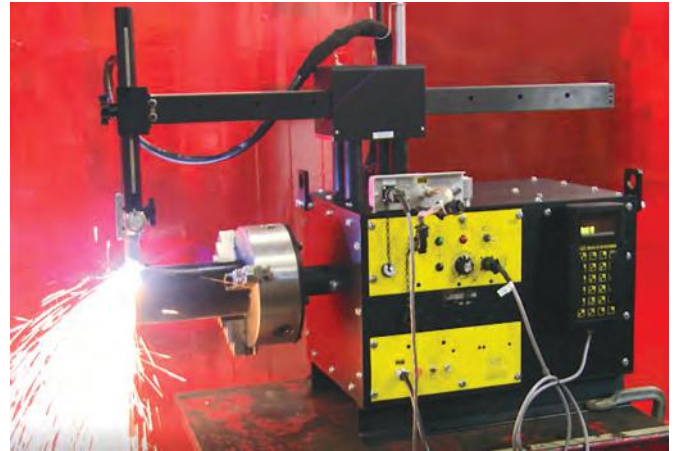

## Features:

- Oxy-fuel or plasma process
- Dual programming capabilities
- Can accommodate pipe sizes ranging from 1- 12" (25-305 mm) in diameter
- Pipe weight capacity of 375 lbs. (170 kg)
- Speed range of 0.2-3.7 rpm
- Made in USA

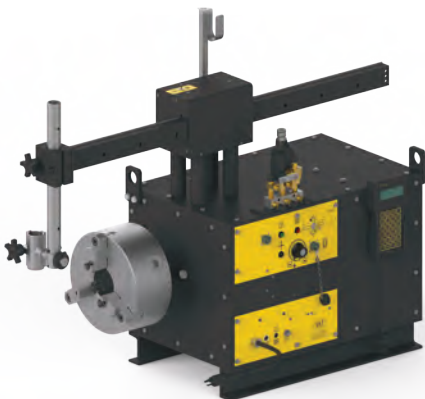

**SE-4PD**  
SEO-4520-OX 120V Oxy-Fuel  
SEO-4522-OX 240V Oxy-Fuel

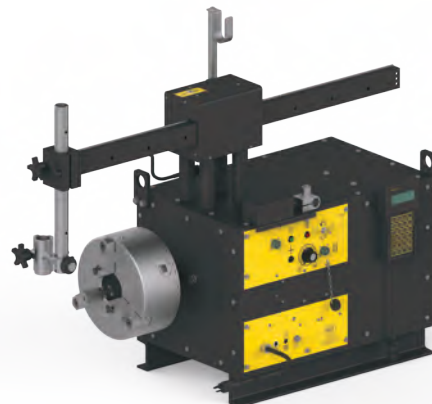

**SE-4PD**  
SEO-4520-PL 120V Plasma  
SEO-4522-PL 240V Plasma

# Programmable Pass Through Pipe Cutting Machine

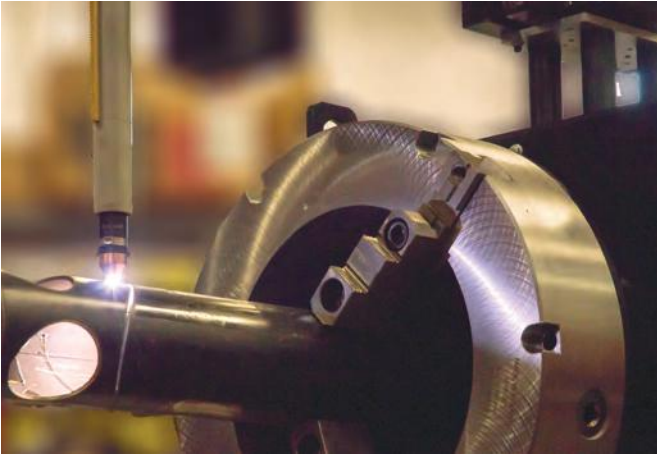

The SE-4PTD is used to cut saddles, offset saddles, laterals, miter cuts and holes on pipe. A second (selectable) program is used for cutting customized shapes in pipe. Also available is Windows based software for programming. This machine can be configured for oxy-fuel, plasma or both. The SE-4PTD eliminates the need to make templates or to layout complex cuts.

## Features:

- Dual programming capabilities
- Pass through cutting diameter from 4-12<sup>3/4</sup> " O.D. (100-325 mm)
- Pipe weight capacity of 375 lbs. (170 kg)
- Internal chucking of pipe (for short lengths) up to 20" (500 mm) diameter.
- Rotation speed 0.2-3 rpm
- Made in USA



### SE-4PTD

SEO-4400-OX 120V Oxy-Fuel  
SEO-4402-OX 240V Oxy-Fuel

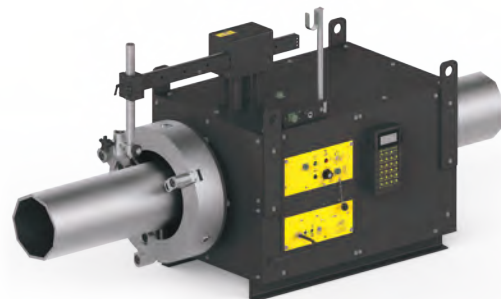

### SE-4PTD

SEO-4400-PL 120V Plasma  
SEO-4402-PL 240V Plasma

# Pipe Coupon Cutting Machine

The **PCC-1** is used for cutting pipe to a desired length or for beveling the edge of a pipe for weld prep. The machine features a self centering speed chuck capable of gripping 0-8" O.D. pipe and 3-11" I.D. pipe. A racking group supports a plasma or oxy-fuel torch which can be setup for square or beveled cuts up to 12" in length. The variable speed control on the PCC-1 can be adjusted from 1-6 rpm. A rotary ground is included on the plasma version and a quick action manifold is supplied on the oxy-fuel version.



## Features:

- Available for oxy-fuel or plasma in 110 and 220 volt models
- Variable speed control from 1-6 rpm
- Able to grip 0-8" O.D. and 3-11" I.D. pipe
- Made in USA
- Capable of cuts up to 12" (305 mm)
- Speed range of 1-6 rpm
- Plasma model includes a rotary ground and the oxy-fuel version is supplied with a quick action manifold

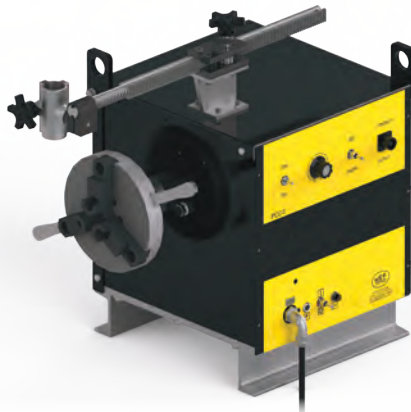

**PCC-1**  
100-0388 110 Volt



# Programmable Pipe Cutter

The **MM1** is a computer controlled machine that automates the cutting of profiles, holes and shapes on pipe with diameters from 4-16" (102-406 mm). It rotates the pipe on its roller bed with a three jaw chuck while simultaneously moving a cutting torch back and forth along the pipe's axis. Pre-programmed shapes such as saddle, hillside, lateral and miter cuts can be made by simply selecting the type of cut from the menu, then entering the diameters of the pipes being processed and pressing the run button to cut your pipe. Also available is Windows based software for programming.

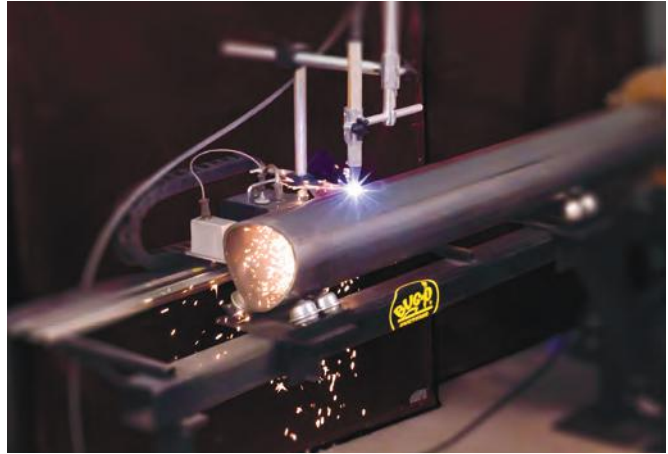

## Features:

- Available for oxy-fuel or plasma process
- Cutting diameter of 4-16" (100-406 mm)
- Eliminates the need for templates, layouts or calculations
- Can cut pipe lengths from 3-38" (76 mm -11.6 m)
- Speed is .2-3 rpm
- Pre-programmed shapes such as saddle, offset saddles, laterals, miter cuts, and holes can be made
- Irregular shapes can be plotted, programmed and saved for future use
- Made in USA

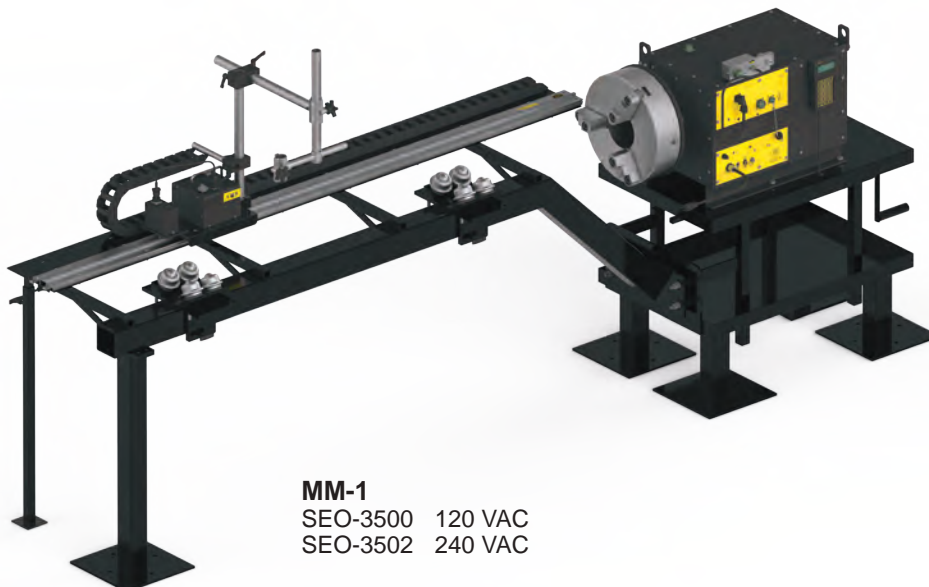

**MM-1**  
SEO-3500 120 VAC  
SEO-3502 240 VAC

# Pipe Cutting and End Preparation - Pre-Programmed and Custom Cuts

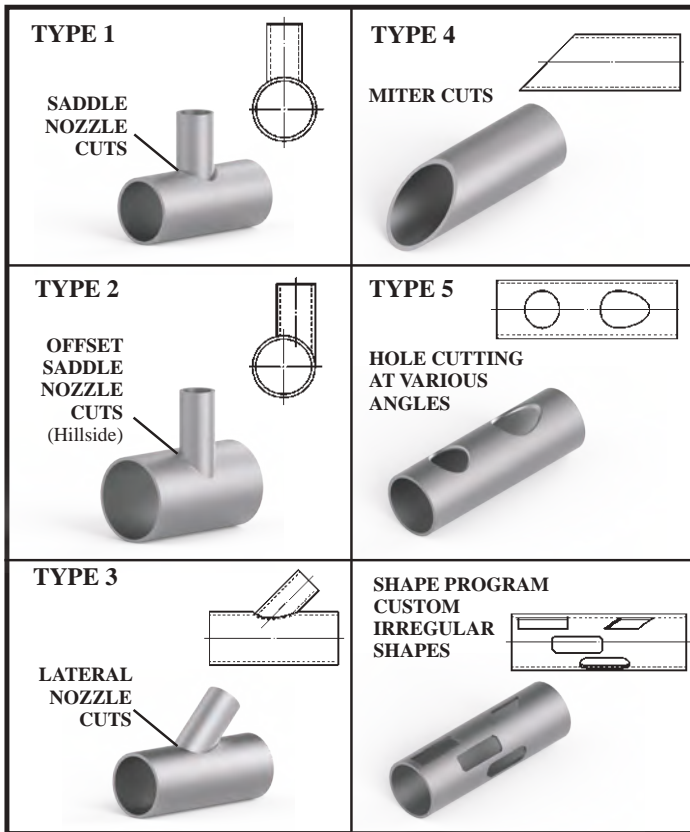

SEGMENT TYPES	QUADRANT			
	#1	#2	#3	#4
1. Clockwise 90° Arc				
2. Counter-Clock wise 90° Arc				
3. X or Y Axis Line				
4. Oblique Line				
5. Functions	WELD/OXY ON	WELD/OXY OFF	WAIT FOR START BUTTON	TIME DELAY
6. Functions	REPEAT ANOTHER STEP	PIPE CUT NUMBER	AUXILIARY MODES	PERCENT SPEED
7. Clockwise Partial Arc				
8. Counter-Clock wise Partial Arc				

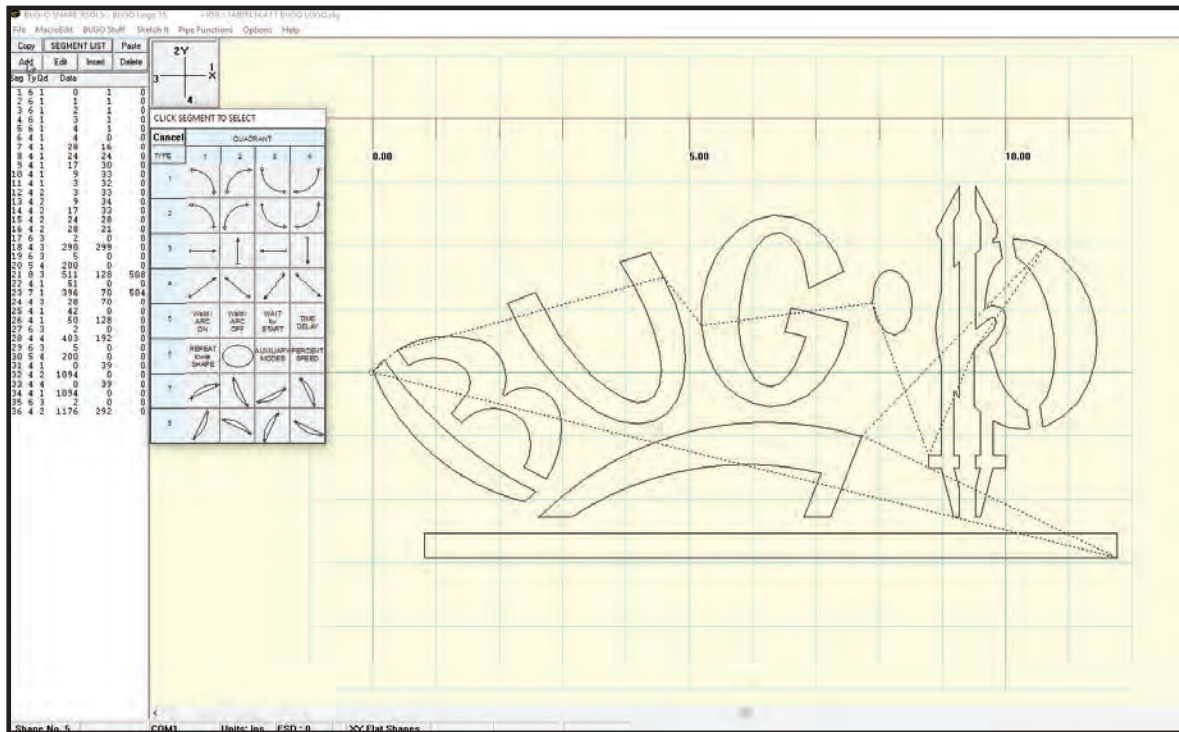

PC Option  
BUG-6140

CAD Interface  
BUG-6240

Wireless Serial  
Connection Set for  
use with PC Option  
BUG-6220

# Custom Mechanization

## High Capacity Modular Drive System



Bug-O offers a Modular Drive System with more than double the standard carrying capacity. The **High Capacity MDS** can carry up to 140 lbs. (64 kg) vertically, and is compatible with all standard MDS components. The High Capacity MDS provides the required power to carry the feeder, wire, and cables to mobilize the complete welding system. For full load carrying capacity, the High Capacity Modular Drive System must travel upon heavy duty rail (call factory for details).

### Features:

- One complete traveling welding platform
- Capable of carrying up to 140 lbs. (64 kg.) vertically (rating includes a 100% safety factor)
- Larger diameter, 1.125" (28.5 mm) chrome moly pinion
- Compatible with all standard MDS components
- Allows for all inclusive welding process application (Bug-O tractor, suitcase feeder, wire and all electrical connections)
- Made in USA

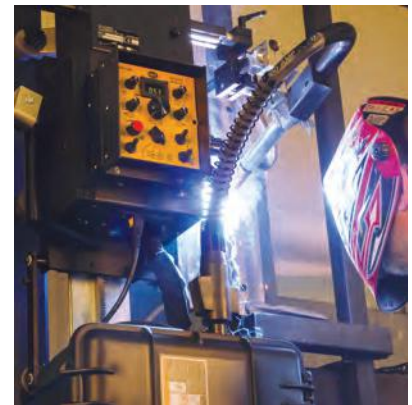

### High Capacity MDS

MPD-1000-HICAP 120 VAC  
MPD-1002-HICAP 240 VAC



# All Position Overlay System

The **All Position Overlay System** is designed for pulp digesters, boiler tube walls or any vessel or surface that requires overlay repair. The system will travel at a regulated, precise travel speed producing consistent uniform overlay patterns. A welding current sensor monitors and controls the welding torch height on pitted or irregular surfaces. The system can be customized for job specific applications on circumferences or flat walls and can be configured to handle a variety of operating windows. The entire system is portable and can be broken down into small pieces for moving thru small manholes or openings.



## Features:

- Customizable for job specific applications
- Portable system that can be taken to the work
- Pendulum weaver included along with welding torch height control
- Can be adapted for horizontal/step-up welding
- 2-20 ipm (50-508 mm/min) travel speed
- Full pendant control
- Cycle select module can be pre-set for continuous cycle, bi-directional stop at limit or rapid return at limit to start position
- Made in USA

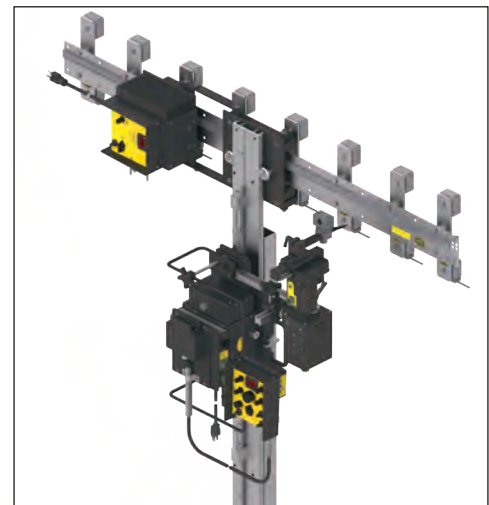

Close-up view

Overlay System

# DCW-5



Bug-O addresses the need to utilize the latest advancements in pulsed MIG and submerged arc process control for its circle welders. This Circle Welder System is now available for Digitally Controlled Welding Power Sources. All digital control signals can now be passed to a continuously turning wire feeder for advanced process welds. Now you can have all the power and arc characteristics that the new digitally controlled power sources can deliver, along with no hose or cable wrap-up regardless of direction or rotation.

The **DCW-5-L Circle Welder**, equipped with Lincoln Electric® Power Feed 84® wire feeder, is capable of welding 1-12" (25.4-304.8 mm) diameters. This machine can be used for GMAW, GMAW-P or FCAW welding process. There are eight user memories for complete welding procedure recall, and pre-programmed auto settings to simplify process procedures.

The **DCW-5-O Circle Welder**, equipped with OTC-DAIHEN AF-4012 wire feeder, provides OTC patented wave pulse process with 1-12" (25.4-304.8 mm) diameter range.

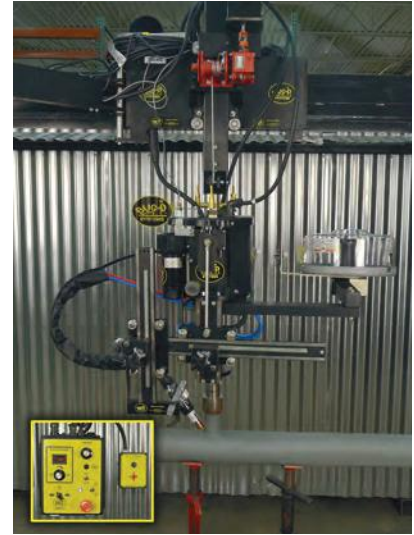

## Features:

- GMAW, GMAW-P, FCAW advanced weld process control
- All digital control signals passed to a continuously turning wire feeder
- Rotation speed .5-5.9 rpm
- No hose or cable wrap-up regardless of direction or rotation
- Rise and fall cam with 5" (125 mm) of travel
- Made in USA



DCW-5

## DCW-18

The **DCW-18-L Circle Welder**, equipped with Lincoln Electric® MAXsa® 10 Controller for Power Wave® AC/DC 1000® is capable of welding nozzles with a diameter range of 10-50 inch diameter. The machine is set up for sub arc process. Features of the machine include eight procedure memories and user friendly controls.



The **DCW-18-M Circle Welder**, equipped with Miller® Digital interface for use with Miller® Digital series power sources. It is capable of welding nozzle diameters from 10-50" and is set up for SAW process.



### Features:

- GMAW-P and SAW process control
- All digital control signals passed to a continuously turning wire feeder
- Rotation speed of .06-.72 rpm
- No hose or cable wrap-up regardless of direction or rotation
- Rise and fall cam with 7" (177.8 mm) of travel
- Made in USA



DCW-18



## MM-5



The **MM-5** is a computer-controlled machine that automates the cutting of profiles, holes, nozzles and shapes on pipe with diameters from 4" to 39.375" (10-100 cm). It features built in Auto Height Control for plasma cutting process. The MM-5 rotates the pipe on its roller bed with a three jaw chuck, while simultaneously moving a cutting torch back and forth along the pipe's axis. Pre-programmed shapes such as saddle, hillside, lateral and miter cuts can be made by simply selecting the type of cut from the menu, then entering the diameters of the pipes and pressing the run button to cut your pipe. There is no need for templates, time consuming layout or calculations. In addition, irregular or custom shapes can be plotted, programmed and saved for future use.

### Features:

- Available for oxy-fuel or plasma cutting process in 120 and 240 volt models
- Built in automatic height control for plasma cutting process
- Cutting diameter of 4" - 39.375" (10-100 cm)
- Made in USA
- Eliminates the need for templates, layouts or calculations
- Pre-programmed shapes such as saddle, offset saddles, laterals, miter cuts, and holes can be made
- Irregular shapes can be plotted, pre-programmed and saved for future use

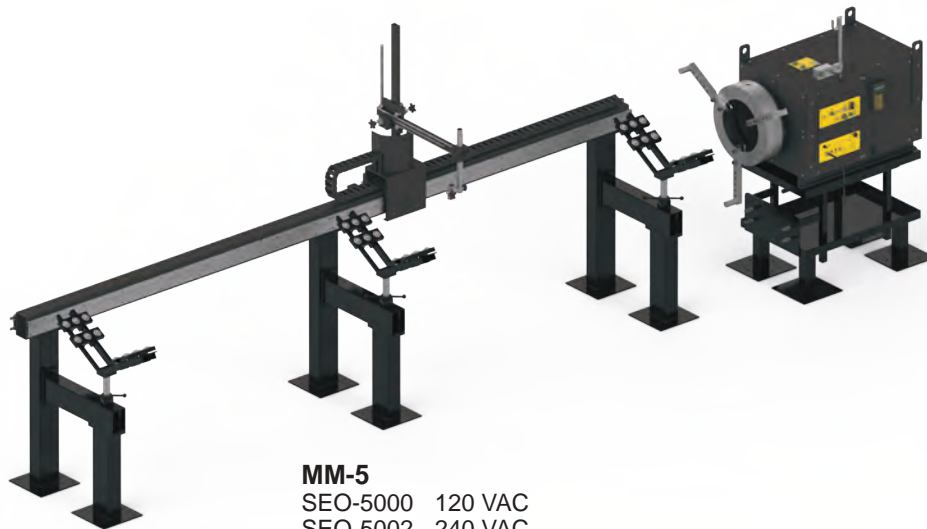

**MM-5**  
SEO-5000 120 VAC  
SEO-5002 240 VAC

# Girth Welders

Bug-O Systems offers **Automatic Girth Welders** for tank fabrication applications. They are convertible for both bottom up and top down construction. Bug-O Girth Welders are also capable of being used as a pair to construct a dual sided girth welder. Special models can be built per customer's request.

Unlike other girth welders on the market, the BGW (Bug-O Girth Welder) Series comes standard with a Dual Drive System and other features unique to our machines. This self-propelled submerged arc welding system can reduce field storage tank welding time by 40% by increasing arc on time and reducing weld defects. The models run directly on the tank and carry the operator, eliminating the need for scaffolding while ensuring operator comfort and safety. The Girth Welders, due to their modular design, are applicable for top down or bottom up constructed single or double wall storage tanks. They are designed for internal and external welding. There are four standard units and our design allows us to offer custom-built units for special applications.



## Features:

- Dual drive motor system
- Efficient flux recovery system
- Integrated control panel
- Laser site guide
- Ergonomic operator cabin
- Adjustable weld head and flux belt support system



Girth Welders

# Accessories

## Automatic Height Control

**Automatic Height Control** is a compact easy to use accessory, designed to maintain a constant welding torch-to-work distance. This control can be used with SAW, FCAW and GMAW welding. It includes a solid-state control box and a motorized slide which will bolt onto any standard Bug-O Systems carriage or fixture. It can be used for a wide variety of welding applications where precise control of welding current is critical. This system requires a constant voltage (CV) power supply for operation.



(Included in All AHC Systems)  
CAS-1550



**AHC for Universal Bug-O-Matic**  
BUG-6553



**AHC for Free Standing Torch Support Integration**  
CAS-2100



**AHC for MDS Pendulum Weaver System**  
CAS-2060



**AHC for MDS Linear Weaver System or MDS Straight Line System**  
CAS-2050



# Racking Groups

**Welding Groups**, with rack and pinion adjustment, align a welding gun to the weld joint.

**Cutting Groups** utilize rack and pinion to adjust and align a cutting torch with the cut line.

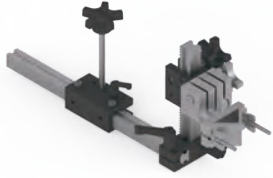

**Machined Rack Welding Group**  
MDS-1040



**Machined Rack Cutting Group**  
MDS-1050



**Dual Torch Welding Group**  
MDS-1075



**Dual Torch Cutting Group**  
MDS-1090

# Panographs

**Panograph Welding Groups** maintain consistent tip to work surface distance. Rack and pinion adjustment positions a welding gun to the weld joint.

**Panograph Cutting Groups** maintain consistent tip to work surface distance. Rack and pinion adjustment positions a cutting torch gun to the cut line.



**Panograph Torch Floater**  
PAN-1000



**Double Torch Panograph**  
PAN-1072



**Welding Panograph**  
PAN-1008



**Mechanical Corner Follower**  
PAN-2145-L, R



**Mechanical Seam Follower**  
PAN-2160

# Torch Supports / Holders



**Welding Support Kit for Go-fer® IV**  
GOF-3255



**Freestanding Torch Support**  
FTS-1020 (110 VAC)  
FTS-1020-240 (240 VAC)



**Torch Incline**  
CAS-2200

**Freestanding Torch Support with Automatic Height Control**  
FTS-1025 (110 VAC)  
FTS-1025-240 (240 VAC)

## Rails



**Aluminum Heavy Duty Rigid Rail**  
ARR-1080 8' (2.37 m) long sections  
ARR-1085 4' (1.18 m) long sections



**Semi-Flex Rail**  
AFR-3000 8' (1.47 m) long sections  
Flexes to min. 15' (5 m) radius



**Aluminum Extra Heavy Duty Rigid Rail**  
ARR-1250 8' (2.37 m) long sections  
ARR-1200 4' (1.18 m) long sections



**Hi-Flex Rail**  
FMD-1050 57.7" (1.47 m) long sections  
Flexes to min. 30" (760 mm) radius



**Bent Rigid Rail**  
BRR-1180 individual section 80" (2032 mm)



**Bent Rigid Rail**  
BRR-3250-XX complete ring rail  
Min. Workpiece Diameter 9" (230 mm)



**Piper Flex Rail**  
PSR-2200 individual section 5" (1.524 m)



**Piper Flex Rail**  
PSR-2000-XX complete ring rail  
Min. Workpiece Diameter 12" (304.8 mm)

# Magnets & Their Accessories



**R.E. On/Off Magnet**  
(for Aluminum Rigid Rail)  
ARM-2010

**Hight Heat Applications\***  
ARM-2010-HH



**Swivel Magnet**  
(for Aluminum Rigid Rail)  
ARM-2325



**R.E. On/Off Magnet**  
(for Semi-Flex Rail)  
AFR-2010

**Hight Heat Applications\***  
AFR-2010-HH



**Magnet w/Release**  
(for Semi-Flex Rail)  
ARM-2425



**R.E. On/Off Magnet**  
(for Hi-Flex Rail)  
FMD-2010

**Hight Heat Applications\***  
FMD-2010-HH



**Magnet w/Release**  
(for Hi-Flex Rail)  
FMD-2325



**Support Bar with R.E. On/Off Magnets**  
(for Bent Rail)  
ARM-2580



**Support Bar with Screw Feet**  
(for Bent Rail)  
ARM-2380

**\*Hight Heat App.** = Rated @180°C (356°F)  
**Standard Heat** = Rated @80°C (176°F)

# Carriages & Vacuum Supports

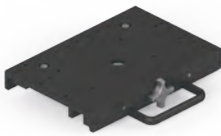

**Releasable Carriage**  
(for Rigid & Semi-Flex Rail)  
MPD-1065



**Hi-Flex Carriage**  
(for Hi-Flex Rail)  
FMD-1105



**Split Carriage Releasable from Rail**  
(for Bent Rigid Rail)  
BUG-5910

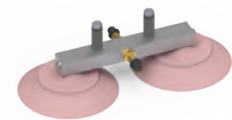

**Vacuum Bar Assembly for Non-Ferrous Material**  
(for Hi-Flex Rail)  
FMD-1036



**Vacuum Bar Assembly for Non-Ferrous Material**  
(for Rigid & Semi-Flex Rail)  
sold separately  
ARV-1036



**Vacuum Pump Kit**  
ARV-2020 110 VAC  
ARV-2030 240 VAC

## Batteries

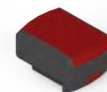

**Battery Replacement**  
KBUG-1201-BAT

**120V Battery Charger**  
KBUG-1205-BAT

**240V Battery Charger**  
KBUG-1206-BAT



